VQ SERIES

LATEST TECHNOLOGY, HIGH PERFORMANCE END MILLS
FOR STAINLESS AND DIFFICULT-TO-CUT MATERIALS



VQ SERIES

REVOLUTIONARY PERFORMANCE FOR DIFFICULT-TO-CUT-MATERIALS

INNOVATIVE TECHNOLOGY

VQ end mills have been treated with a newly developed (Al, Cr)N group coating that delivers substantially better wear resistance. The surface of the coating has been given a smoothening treatment resulting in better machined surfaces, reduced cutting resistance and improved chip discharge. This is the next generation of coated end mills that deliver long tool life when machining stainless steels and other difficult-to-cut materials.



VQ coating

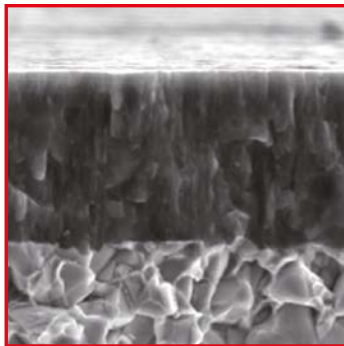

..... Smoothened "ZERO- μ Surface".

..... Newly developed (Al, Cr)N PVD coating.

..... Super-fine-particle, super-hard base material.

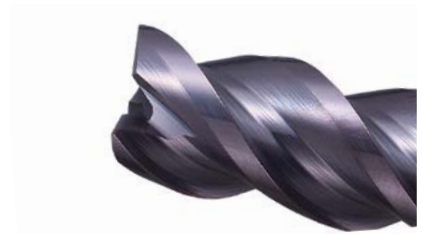

Conventional coating

ZERO- μ SURFACE

With the unique ZERO- μ Surface, the cutting edge retains its sharpness. While previous technologies often resulted in diminished sharpness, the ZERO- μ Surface achieves both smoothness and sharpness, as well as longer tool life.

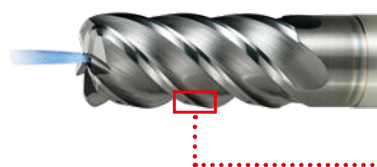

VQ coating



Conventional coating

(Al, Ti, Si) BASED COATING

The (Al, Ti, Si) based coatings maintain their film hardness and heat resistant properties under the harshest of conditions making it highly suitable for applying to end mills for machining Ni-based super alloys.

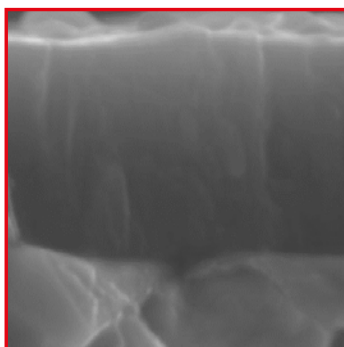

..... New (Al, Ti, Si) based coating

..... High quality grade focusing on wear resistance



VQN coating

VQLCS / VQELCS / VQJCSR / VQLCSR / VQELCSR

END MILL WITH IRREGULAR PITCH FLUTES AND CHIPBREAKER GEOMETRY

UNIQUE END CUTTING EDGE GEOMETRY

The unique end cutting edge geometry achieves high chipping resistance.

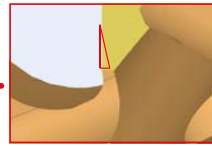
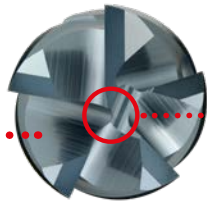

IRREGULAR PITCH FLUTES AND MICRO CLEARANCE ANGLE OF THE PERIPHERAL CUTTING EDGE

Due to its excellent vibration damping properties, chatter and vibration are suppressed making stable machining possible.

CHIPBREAKER FUNCTION

Prevents chip problems by combining great chip breaking capabilities and fracture resistance.

CHIP POCKET GEOMETRY FOR HIGH EFFICIENCY MACHINING

The rigid cross-sectional geometry with excellent chip evacuation properties is ideal for high efficiency machining such as trochoidal milling.

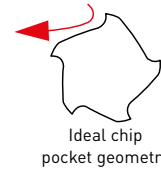

**VQELCS
(5 x DC)**



**VQLCS
(4 x DC)**



**VQJCS
(3 x DC)**



**VQJCSRB
(3 x DC)**



**VQLCSRB
(4 x DC)**



**VQELCSRB
(5 x DC)**



VQJCS / VQLCS

CHIPBREAKER FUNCTION: HIGH-SPEED CAMERA COMPARISON

The excellent chip breaking properties reduces chip clogging and removes chips efficiently while also reducing chips collecting together on the machine.

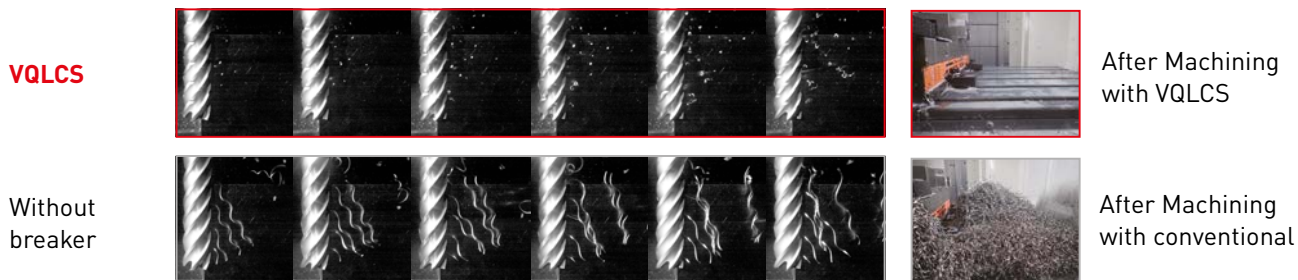

EVALUATION OF TROCHOIDAL MILLING

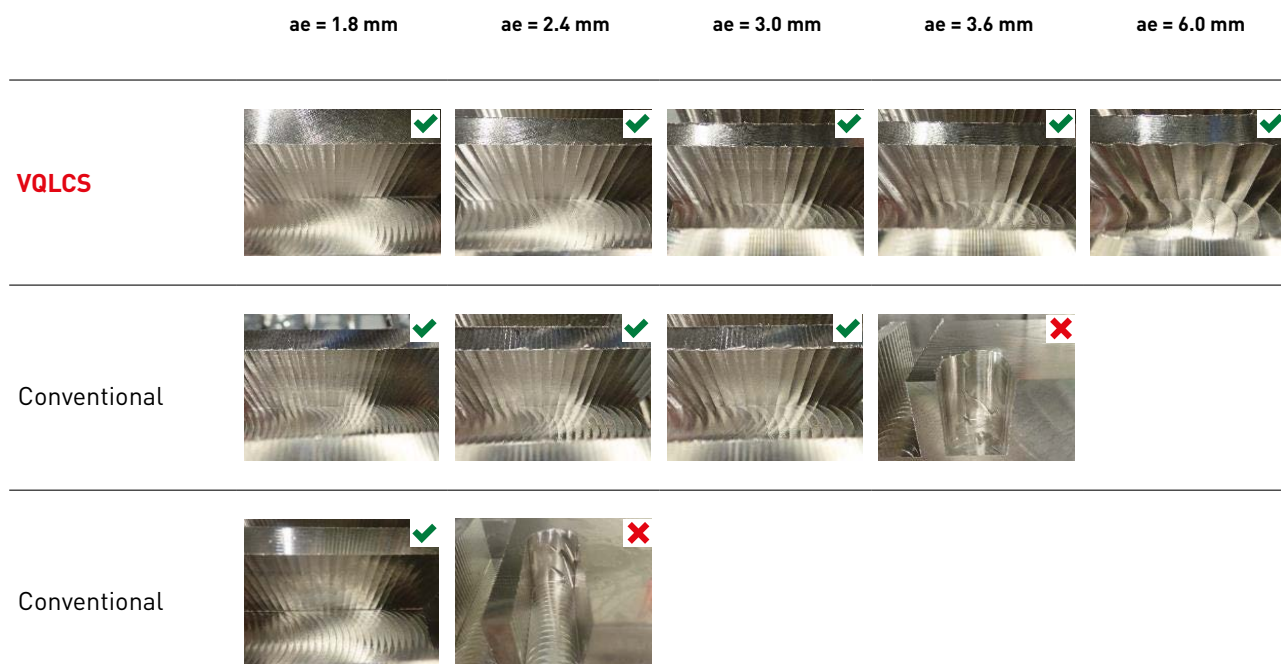

✓ : Achieves stable machining

✗ : Problems caused by chips

Material	1.4301
Tool	VQJCS D1200
Vc (m/min)	100
fz (mm)	0.05
ap (mm)	24 (DCx2)
ae Pitch (mm)	1.8 - 6.0
Slot width (mm)	18 (DCx1.5)
Overhang length (mm)	60 (DCx5)
Cutting mode	Trochoidal milling External coolant (Emulsion)

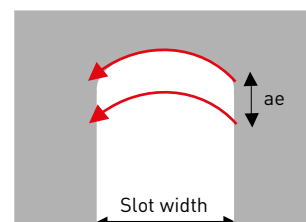
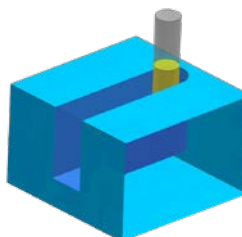

VQ4MVM

MULTIFUNCTIONAL END MILL CAPABLE OF STRONG RAMPING CAPABILITY ON A WIDE RANGE OF MATERIALS

RAMPING IS A METHOD OF SINKING GRADUALLY AS THE TOOL TRAVERSES

This eliminates the need for a pilot hole when machining pockets, thereby reducing costs through tool consolidation. Compared to direct plunge cutting, ramping enables simultaneous multi-axis feed at high speeds to lower machining times. This method is ideal for machining wide and shallow pockets.

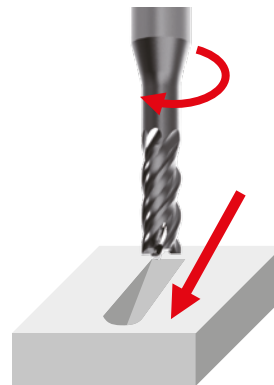

Steep ramping capability

VQ4MVM provides high-performance and multi-functionality. It can perform shoulder milling, grooving and helical machining as well as ramping angles of up to 30° in carbon and alloy steels.

14 sec

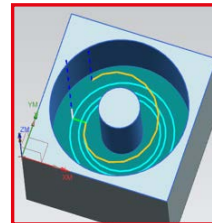

VQ4MVM

Helical and ramping
Only 1 pass needed

27 sec

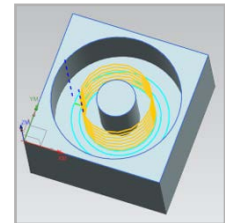

Conventional
Helical milling
7 passes needed

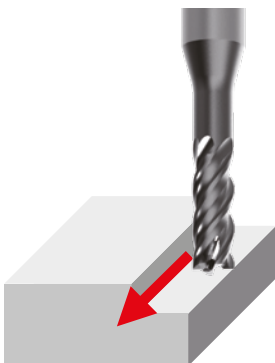

Shoulder milling

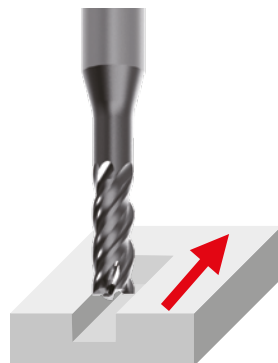

Slot milling



Pocket milling



Helical milling

VQ4MVM

HIGH PERFORMANCE END MILL

NEWLY-DEVELOPED COATING WITH IMPROVED WEAR RESISTANCE

The smoothing treatment of the coating layer reduces cutting resistance and significantly improves chip discharge.

SMART MIRACLE Coating

(Al,Cr)N coating is the most suitable coating for higher efficiency machining.

ZERO- μ Surface

The original surface treatment technology provides smooth coating layer.



SECONDARY GASH

A first and secondary gash provides high chip evacuation that far exceeds conventional designs when ramping.

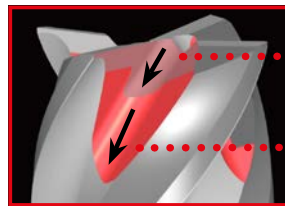

1st Gash

2nd Gash

MICRO RELIEF ANGLE

It exerts a margin effect that plays the role of a guide during machining.

Combined with irregular helix flutes, it improves vibration damping and suppresses burrs.

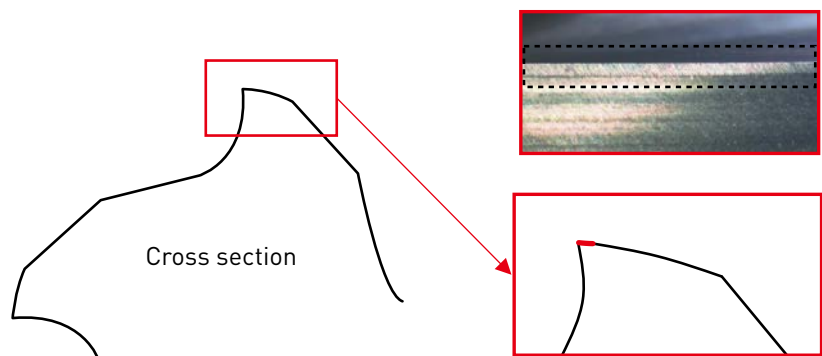

Irregular helix flutes and the micro relief angle improve vibration damping and provides excellent surface finishes.

X5CrNi18-10 $V_c = 100$ m/min, $f_z = 0.05$ mm/t, $a_p = 5$ mm, $a_e = 3$ mm



VQ4MVM



Chatter vibration

Conventional

VQ4MVM

HIGH PERFORMANCE END MILL

CHIP POCKET AND HIGHLY RIGID GEOMETRY

VQ4MVM is suitable for strong ramping machining and chip evacuation performance due to the highly rigid geometry.

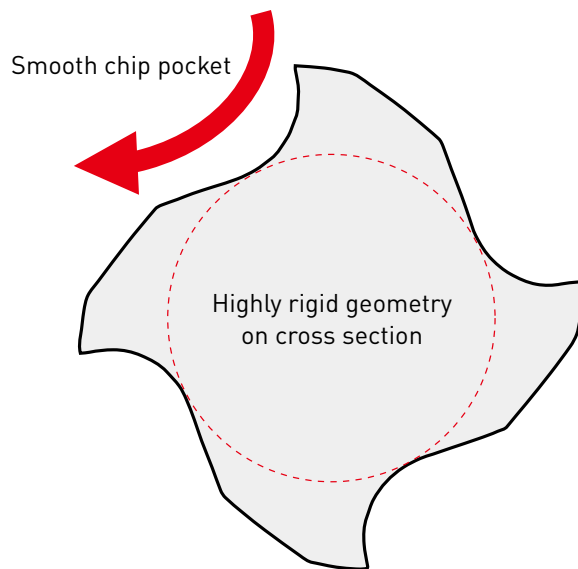

COMPARISON OF RAMPING ANGLES WHEN MACHINING X5CrNi18-10

Provided a good machined surface when machining with a ramping angle of 25°.

Material	X5CrNi18-10
Tool	Ø 10
Vc (m/min)	50
fz (mm)	0.025
ap (mm)	10
ae (mm)	10
Overhang length (mm)	35
Cutting mode	External coolant (Emulsion)
Machine	Vertical M/C (BT50)

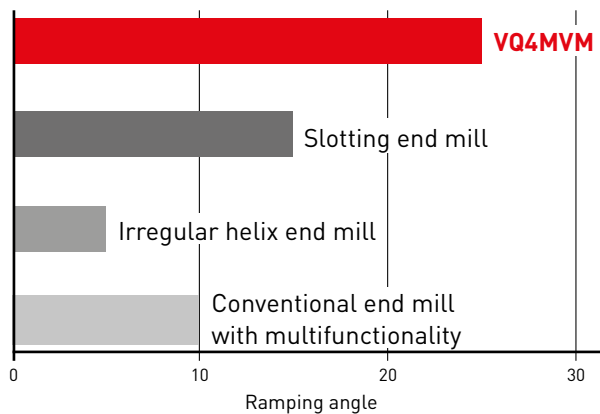

MACHINING SURFACE



VQ4MVM







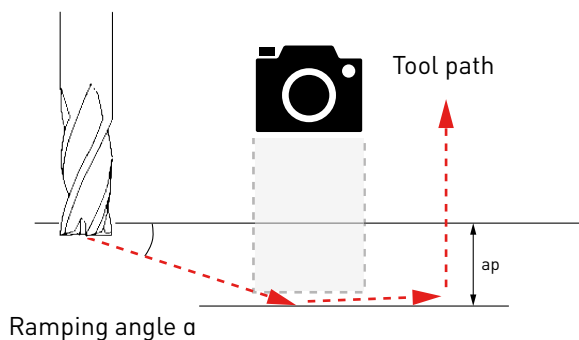





Conventional end mill

SHOOTING POINT















VQ SERIES









CLASSIFICATION

Product code	Shape	DC	P	H	M	S	N	
RADIUS END MILLS								
VQN4/6MVRB	Corner radius, medium cut length, 4 / 6 flute 	3 - 12				⊙		11
VQT5MVRB	Corner radius, medium cut length, 5 flute, irregular helix, with through coolant hole 	16 - 25				⊙		13
NEW VQJCSRB	Corner radius, semi long cut length, 5 flute, irregular pitch flutes, chipbreaker 	6 - 20	⊙		⊙	⊙	○	15
NEW VQLCSRB	Corner radius, long cut length, 5 flute, irregular pitch flutes, chipbreaker 	6 - 20	⊙		⊙	⊙	○	18
NEW VQELCSRB	Corner radius, extra long cut length, 5 flute, irregular pitch flutes, chipbreaker 	6 - 20	⊙		⊙	⊙	○	21
VQ6MHVRBCH	Corner radius end mill, medium cut length, 6 flute, irregular helix flutes, with multiple internal through coolant holes 	10 - 20			⊙	⊙		24
VQMHRB	Corner radius end mill, medium cut length, 4 flute, irregular helix flutes 	2 - 20	⊙		⊙	⊙	○	26
VQMHVRBF	Corner radius finishing end mill, Medium cut length, 4 flute, Irregular helix flutes 	6 - 16	⊙		⊙	⊙	○	36
VQHVRB	Corner radius, short cut length, 4 flute, irregular helix flutes 	1 - 4	○		⊙	⊙	○	39
VQFDRB	Duplex corner radius end mill for high speed cutting 	3 - 6	○	○	⊙	⊙		41

VQ SERIES – CLASSIFICATION

Product code	Shape	DC	P	H	M	S	N	
SQUARE END MILLS								
VQJCS	End mill, semi long cut length (3 x DC), 5 flute, irregular pitch flutes, chipbreaker	 6 – 20	◎		◎	◎	○	43
VQLCS	End mill, long cut length (4 x DC), 5 flute, irregular pitch flutes, chipbreaker	 6 – 12 NEW 16, 20	◎		◎	◎	○	45
NEW VQELCS	End mill, Extra long cut length, 5 flute, irregular pitch flutes, chipbreaker	 6 – 20	◎		◎	◎	○	47
VQ6MHVCH	End mill, medium cut length, 6 flute, irregular helix flutes, with multiple internal through coolant holes	 10 – 20			◎	◎		49
VQXL	End mill, short cut length, 4 flute, long neck	 0.2 – 1	◎		◎	◎	○	51
VQMHZV	End mill, Medium cut length, 3 flute for plunging and slotting	 1 – 20	◎		◎	◎	○	55
VQMHZVOH	End mill, medium cut length, 3 flute for plunging and slotting, with multiple internal through coolant holes	 6 – 16	◎		◎	◎	○	70
VQ4MVM	End mill, Medium cut length, 4 flute, For multi functional machining	 4 – 12	◎	○	◎	○		75
VQMHV	End mill, medium cut length, 4 flute, irregular helix flutes, offset types for vertical wall machining and deep applications	 1 – 25	◎		◎	◎	○	79
VQJHV	End mill, semi-long cut length, 4 flute, irregular helix flutes	 1 – 20	◎		◎	◎	○	89
VQSVR	Roughing end mill, short cut length, 4 flute, irregular helix flutes	 3 – 20	◎		◎	◎	○	92

VQ SERIES – CLASSIFICATION

Product code	Shape	DC	P	H	M	S	N	
BALL NOSE END MILLS								
VQN2MB	Ball nose, medium cut length, 2 flute		1 – 12			⊙		101
VQ2XLB	Ball nose, short cut length, 2 flute, long neck		1 – 3	○		⊙	○	103
VQN4MB	Ball nose, medium cut length, 4 flute		2 – 12			⊙		105
VQN4MBF	Ball nose, medium cut length, 4 flute		2 – 12			⊙		107
VQ4SVB	Ball nose, short cut length, 4 flute, variable curve		1 – 6	⊙		⊙	○	109
VQ4WB	Multi-functional Lollipop, short cut length, 4 flute		1 – 6	⊙		⊙	○	111
FORM END MILL								
VQT6UR	Conical taper barrel, medium cut length, 6 flute		8 – 12	○		○	○	114

VQN4 / 6MVRB



CORNER RADIUS, MEDIUM CUT LENGTH, 4 / 6 FLUTE

S



VQN4MVRB



VQN6MVRB



VQN4	VQN6
±0.015	±0.02



DC ≤ 12
0
-0.02



DCONMS = 6	DCONMS = 8, 12	DCONMS = 12
0	0	0
-0.008	-0.009	-0.012

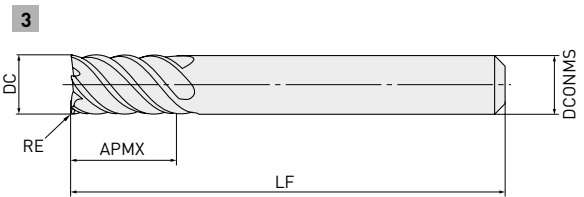
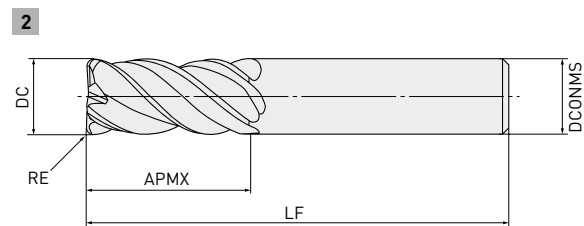
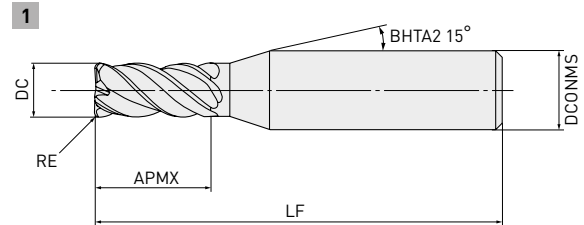

- [Al, Ti, Si] N-based coating exhibits excellent wear and chipping resistance when machining heat resistant super alloys.
- Optimised number of flutes for efficient and stable machining.

Order number	Stock	DC	RE	APMX	LF	DCONMS	ZEFP	Type
VQN4MVRBD0300R030	●	3	0.3	7	45	6	4	1
VQN4MVRBD0300R050	●	3	0.5	7	45	6	4	1
VQN4MVRBD0400R030	●	4	0.3	10	45	6	4	1
VQN4MVRBD0400R050	●	4	0.5	10	45	6	4	1
VQN4MVRBD0500R050	●	5	0.5	12	50	6	4	1
VQN4MVRBD0600R050	●	6	0.5	13	50	6	4	2
VQN4MVRBD0600R100	●	6	1	13	50	6	4	2
VQN6MVRBD0800R050	●	8	0.5	19	60	8	6	3
VQN6MVRBD0800R100	●	8	1	19	60	8	6	3
VQN6MVRBD1000R050	●	10	0.5	22	70	10	6	3
VQN6MVRBD1000R100	●	10	1	22	70	10	6	3
VQN6MVRBD1200R050	●	12	0.5	26	75	12	6	3
VQN6MVRBD1200R100	●	12	1	26	75	12	6	3

1/1



VQN4/6MVRB

RECOMMENDED CUTTING CONDITIONS

SIDE MILLING

Material	DC	ZEFP	n	Vf	ap	ae
S Nickel-based heat resistant super alloy	3	4	4200	340	4.5	0.3
	4	4	3200	260	6	0.4
	5	4	2500	300	7.5	0.5
	6	4	2100	250	9	0.6
	8	6	1600	290	12	0.8
	10	6	1300	310	15	1
	12	6	1100	260	18	1.2

1/1



SLOT MILLING

Material	DC	ZEFP	n	Vf	ap
S Nickel-based heat resistant super alloy	3	4	3200	260	1.5
	4	4	2400	190	2
	5	4	1900	230	2.5
	6	4	1600	190	3
	8	6	1200	140	4
	10	6	1000	120	5
	12	6	800	140	6

1/1

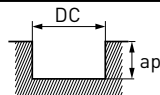

1. For machining heat resistant super alloys, the use of water-soluble coolant is effective.
2. Chattering can still occur if the machine rigidity and clamping method are insufficient.
In these cases the feed and speed should be reduced proportionately.
3. If the depth of cut is shallow, the revolution and feed rate can be increased.

VQT5MVRB



40°
41.5°
43°



CORNER RADIUS, MEDIUM CUT LENGTH, 5 FLUTE, IRREGULAR HELIX, WITH THROUGH COOLANT HOLE

S

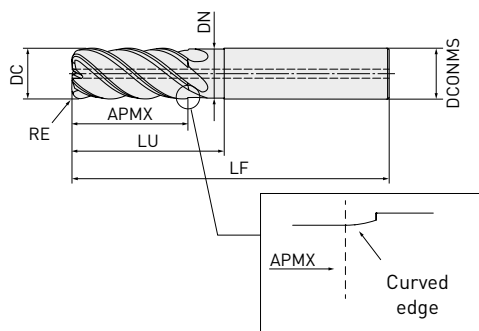

RE

±0.02



DC < 16 20 < DC < 25

0 0
- 0.03 - 0.04



DCONMS = 16 20 < DCONMS < 25

0 0
- 0.011 - 0.013

- Flute geometry suitable for deep slotting and provides effective chip evacuation.
- Sharp cutting edges enable long tool life when machining titanium alloys.

Order number	Stock	DC	RE	APMX	LU	DN	LF	DCONMS	ZEFP
VQT5MVRB160R100N48C	●	16	1	35	48	15.5	120	16	
VQT5MVRB160R300N48C	●	16	3	35	48	15.5	120	16	
VQT5MVRB160R400N48C	●	16	4	35	48	15.5	120	16	
VQT5MVRB200R100N60C	●	20	1	45	60	19.5	135	20	
VQT5MVRB200R300N60C	●	20	3	45	60	19.5	135	20	
VQT5MVRB200R400N60C	●	20	4	45	60	19.5	135	20	5
VQT5MVRB200R600N60C	●	20	6	45	60	19.5	135	20	
VQT5MVRB250R100N75C	●	25	1	55	75	24.5	155	25	
VQT5MVRB250R300N75C	●	25	3	55	75	24.5	155	25	
VQT5MVRB250R400N75C	●	25	4	55	75	24.5	155	25	
VQT5MVRB250R600N75C	●	25	6	55	75	24.5	155	25	

1/1

1. SMART MIRACLE coating has very low electrical conductivity; therefore, an electrical contact type of tool setter may not work. When measuring the tool length, please use a mechanical contact type or a laser tool setter.
2. Non-standard corner R sizes are available by special order. Please contact us for details.



VQT5MVRB

RECOMMENDED CUTTING CONDITIONS

SHOULDER MILLING

Material Overhang length DC x 3

Material		DC	Vc	n	Vf	ap	ae
S	Titanium alloy Ti-6Al-4V etc.	16	80	1600	800	32	2.4
		20	80	1300	650	40	3.0
		25	80	1000	500	50	3.8

1/1

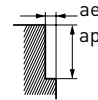

SLOT MILLING

Material Depth of cut DC x 1

Material		RE	DC	Vc	n	Vf	ap
S	Titanium alloy Ti-6Al-4V etc.	1-4	16	60	1200	420	16
			16	60	1200	300	16
			20	60	950	330	20
			20	60	950	238	20
			25	50	640	220	25
			25	50	640	160	25

1/1

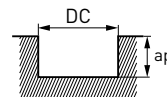

Material Depth of cut DC x 2

Material		RE	DC	Vc	n	Vf	ap
S	Titanium alloy Ti-6Al-4V etc.	1-4	16	60	1200	240	32
			16	60	1200	180	32
			20	60	950	190	40
			20	60	950	143	40
			25	50	640	130	50
			25	50	640	96	50

1/1

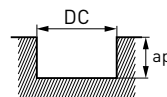

1. SMART MIRACLE coating has very low electrical conductivity; therefore, an electrical contact type of tool setter may not work. When measuring the tool length, please use a mechanical contact type or a laser tool setter.
2. When machining titanium alloys, the use of water-soluble cutting fluid is effective.
3. The irregular helix flute end mill has a larger effect on controlling vibration when compared to standard end mills. However, if the rigidity of the machine or the work material installation is poor, vibration or abnormal sound can occur. In this case, please reduce the speed and feed rate proportionately, or set a lower depth of cut.
4. If the depth of cut is smaller, the speed and feed rate can be increased.
5. When machining deep slots where the depth of cut exceeds the diameter DC, use a high strength holder or one equipped with a retaining mechanism. Additionally ensure the clamping and workpiece rigidity are sufficient.

VQJCSRB



CORNER RADIUS, SEMI LONG CUT LENGTH, 5 FLUTE, IRREGULAR PITCH FLUTES, CHIPBREAKER

P M N S

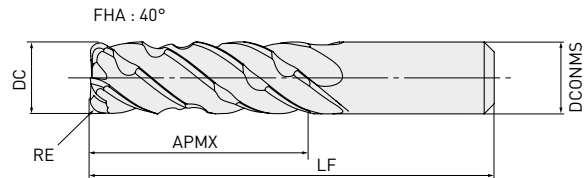

RE ≤ 0.3 RE ≥ 0.5

±0.015 ±0.020



DC ≤ 12 DC > 12

0 0
- 0.030 - 0.040



DCONMS = 6 DCONMS = 8, 10 DCONMS = 12 DCONMS = 16 DCONMS = 20

0 0 0 0 0
- 0.005 - 0.006 - 0.008 - 0.011 - 0.013

- Chipbreaker type end mill for efficient chip breaking capabilities that also provides good surface finishes.
- A high rigidity SMART MIRACLE vibration damping end mill for high efficiency trochoidal milling.

Order number	Stock	DC	RE	APMX	LF	DCONMS	ZEFP
VQJCSRBD0600R010	★	6	0.1	18	70	6	5
VQJCSRBD0600R020	★	6	0.2	18	70	6	5
VQJCSRBD0600R030	●	6	0.3	18	70	6	5
VQJCSRBD0600R050	●	6	0.5	18	70	6	5
VQJCSRBD0600R100	●	6	1.0	18	70	6	5
VQJCSRBD0800R020	★	8	0.2	24	80	8	5
VQJCSRBD0800R030	●	8	0.3	24	80	8	5
VQJCSRBD0800R050	●	8	0.5	24	80	8	5
VQJCSRBD0800R100	●	8	1.0	24	80	8	5
VQJCSRBD0800R150	●	8	1.5	24	80	8	5
VQJCSRBD0800R200	★	8	2.0	24	80	8	5
VQJCSRBD1000R020	★	10	0.2	30	90	10	5
VQJCSRBD1000R030	★	10	0.3	30	90	10	5
VQJCSRBD1000R050	●	10	0.5	30	90	10	5
VQJCSRBD1000R100	●	10	1.0	30	90	10	5
VQJCSRBD1000R150	●	10	1.5	30	90	10	5
VQJCSRBD1000R200	●	10	2.0	30	90	10	5

1/2

1. SMART MIRACLE coating has very low electrical conductivity; therefore, an electrical contact type of tool setter may not work. When measuring the tool length, please use a mechanical contact type or a laser tool setter.



● : Inventory maintained. ★ : Inventory maintained in Japan.

VQJCSRB – CORNER RADIUS, SEMI LONG CUT LENGTH, 5 FLUTE, IRREGULAR PITCH FLUTES, CHIPBREAKER

Order number	Stock	DC	RE	APMX	LF	DCONMS	ZEFP
VQJCSRBD1000R250	★	10	2.5	30	90	10	5
VQJCSRBD1200R050	●	12	0.5	36	100	12	5
VQJCSRBD1200R100	●	12	1.0	36	100	12	5
VQJCSRBD1200R150	●	12	1.5	36	100	12	5
VQJCSRBD1200R200	●	12	2.0	36	100	12	5
VQJCSRBD1200R250	★	12	2.5	36	100	12	5
VQJCSRBD1200R300	●	12	3.0	36	100	12	5
VQJCSRBD1600R050	★	16	0.5	48	110	16	5
VQJCSRBD1600R100	●	16	1.0	48	110	16	5
VQJCSRBD1600R200	●	16	2.0	48	110	16	5
VQJCSRBD1600R250	★	16	2.5	48	110	16	5
VQJCSRBD1600R300	●	16	3.0	48	110	16	5
VQJCSRBD1600R400	★	16	4.0	48	110	16	5
VQJCSRBD1600R500	●	16	5.0	48	110	16	5
VQJCSRBD1600R600	★	16	6.0	48	110	16	5
VQJCSRBD2000R050	★	20	0.5	60	125	20	5
VQJCSRBD2000R100	●	20	1.0	60	125	20	5
VQJCSRBD2000R200	●	20	2.0	60	125	20	5
VQJCSRBD2000R250	★	20	2.5	60	125	20	5
VQJCSRBD2000R300	●	20	3.0	60	125	20	5
VQJCSRBD2000R400	★	20	4.0	60	125	20	5
VQJCSRBD2000R500	●	20	5.0	60	125	20	5
VQJCSRBD2000R600	★	20	6.0	60	125	20	5

2/2

1. SMART MIRACLE coating has very low electrical conductivity; therefore, an electrical contact type of tool setter may not work. When measuring the tool length, please use a mechanical contact type or a laser tool setter.



VQJCSRB

RECOMMENDED CUTTING CONDITIONS

SIDE MILLING

Material	DC	Vc	n	Vf	ap	ae	hm	h max	
P Carbon steel, Alloy steel, Mild steel	6	200	10600	1800	18	0.9	0.010	0.019	
	8	200	8000	1800	24	1.2	0.013	0.025	
	10	200	6400	1700	30	1.5	0.016	0.029	
	12	200	5300	1700	36	1.8	0.019	0.035	
	16	200	4000	1400	48	2.4	0.020	0.039	
	20	200	3200	1200	60	3.0	0.023	0.043	
	Pre-hardened steel, Alloy tool steel	6	180	9500	1500	18	0.9	0.009	0.017
		8	180	7200	1500	24	1.2	0.012	0.023
		10	180	5700	1400	30	1.5	0.015	0.028
		12	180	4800	1400	36	1.8	0.017	0.032
16		180	3600	1200	48	2.4	0.018	0.035	
M Austenitic, Ferritic and martensitic stainless steel,	6	120	6400	1000	18	0.5	0.006	0.012	
	8	120	4800	1000	24	0.6	0.008	0.016	
	10	120	3800	900	30	0.8	0.010	0.019	
S Titanium alloy	12	120	3200	800	36	0.9	0.011	0.021	
	16	120	2400	700	48	1.2	0.012	0.023	
	20	120	1900	600	60	1.5	0.013	0.026	
M Hardened stainless steel, Cobalt chromium alloy	6	100	5300	800	18	0.5	0.006	0.012	
	8	100	4000	800	24	0.6	0.008	0.016	
	10	100	3200	800	30	0.8	0.010	0.019	
	12	100	2700	700	36	0.9	0.011	0.021	
	16	100	2000	600	48	1.2	0.012	0.023	
N Copper, Copper alloy	20	100	1600	500	60	1.5	0.013	0.026	
	6	220	11700	2100	18	0.9	0.010	0.019	
	8	220	8800	2100	24	1.2	0.014	0.026	
	10	220	7000	1800	30	1.5	0.015	0.028	
	12	220	5800	1800	36	1.8	0.018	0.034	
S Heat resistant alloy	16	220	4400	1500	48	2.4	0.020	0.038	
	20	220	3500	1400	60	3.0	0.022	0.042	
	6	40	2100	200	18	0.18	0.002	0.004	
	8	40	1600	200	24	0.24	0.003	0.006	
	10	40	1300	200	30	0.30	0.003	0.007	
	12	40	1100	100	36	0.36	0.003	0.007	
	16	40	800	100	48	0.48	0.004	0.007	
	20	40	600	100	60	0.60	0.004	0.007	

1/1

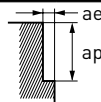

1. SMART MIRACLE coating has very low electrical conductivity; therefore, an electrical contact type of tool setter may not work. When measuring the tool length, please use a mechanical contact type or a laser tool setter.
2. The irregular pitch flute end mill has a larger effect on controlling vibration when compared to standard end mills. However, if the rigidity of the machine or the workpiece material installation is poor, vibration or abnormal sounds can occur. In that case, please adjust the revolution, feed rate and depth of cut.
3. The revolution and feed rate can be increased with a smaller depth of cut.
4. For machining stainless steel, titanium alloys and heat resistant alloys, the use of water-soluble coolant is effective.

VQLCSRB



CORNER RADIUS, LONG CUT LENGTH, 5 FLUTE, IRREGULAR PITCH FLUTES, CHIPBREAKER

P M N S

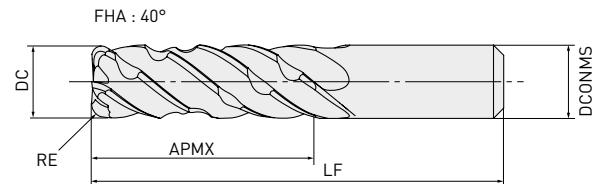

RE ≤ 0.3 RE ≥ 0.5

±0.015 ±0.020



DC ≤ 12 DC > 12

0 0
- 0.030 - 0.040



DCONMS = 6 DCONMS = 8, 10 DCONMS = 12 DCONMS = 16 DCONMS = 20

0 0 0 0 0
- 0.005 - 0.006 - 0.008 - 0.011 - 0.013

- Chipbreaker type end mill for efficient chip breaking capabilities that also provides good surface finishes.
- A high rigidity SMART MIRACLE vibration damping end mill for high efficiency trochoidal milling.

Order number	Stock	DC	RE	APMX	LF	DCONMS	ZEFP
VQLCSRBD0600R010	★	6	0.1	24	70	6	5
VQLCSRBD0600R020	★	6	0.2	24	70	6	5
VQLCSRBD0600R030	●	6	0.3	24	70	6	5
VQLCSRBD0600R050	●	6	0.5	24	70	6	5
VQLCSRBD0600R100	●	6	1.0	24	70	6	5
VQLCSRBD0800R020	★	8	0.2	32	90	8	5
VQLCSRBD0800R030	●	8	0.3	32	90	8	5
VQLCSRBD0800R050	●	8	0.5	32	90	8	5
VQLCSRBD0800R100	●	8	1.0	32	90	8	5
VQLCSRBD0800R150	●	8	1.5	32	90	8	5
VQLCSRBD0800R200	★	8	2.0	32	90	8	5
VQLCSRBD1000R020	★	10	0.2	40	100	10	5
VQLCSRBD1000R030	★	10	0.3	40	100	10	5
VQLCSRBD1000R050	●	10	0.5	40	100	10	5
VQLCSRBD1000R100	●	10	1.0	40	100	10	5
VQLCSRBD1000R150	●	10	1.5	40	100	10	5
VQLCSRBD1000R200	●	10	2.0	40	100	10	5

1/2

1. SMART MIRACLE coating has very low electrical conductivity; therefore, an electrical contact type of tool setter may not work. When measuring the tool length, please use a mechanical contact type or a laser tool setter.



VQLCSRB – CORNER RADIUS, LONG CUT LENGTH, 5 FLUTE, IRREGULAR PITCH FLUTES, CHIPBREAKER

Order number	Stock	DC	RE	APMX	LF	DCONMS	ZEFP
VQLCSRBD1000R250	★	10	2.5	40	100	10	5
VQLCSRBD1200R050	●	12	0.5	48	110	12	5
VQLCSRBD1200R100	●	12	1.0	48	110	12	5
VQLCSRBD1200R150	●	12	1.5	48	110	12	5
VQLCSRBD1200R200	●	12	2.0	48	110	12	5
VQLCSRBD1200R250	★	12	2.5	48	110	12	5
VQLCSRBD1200R300	●	12	3.0	48	110	12	5
VQLCSRBD1600R050	★	16	0.5	64	130	16	5
VQLCSRBD1600R100	●	16	1.0	64	130	16	5
VQLCSRBD1600R200	●	16	2.0	64	130	16	5
VQLCSRBD1600R250	●	16	2.5	64	130	16	5
VQLCSRBD1600R300	●	16	3.0	64	130	16	5
VQLCSRBD1600R400	★	16	4.0	64	130	16	5
VQLCSRBD1600R500	●	16	5.0	64	130	16	5
VQLCSRBD1600R600	★	16	6.0	64	130	16	5
VQLCSRBD2000R050	★	20	0.5	80	150	20	5
VQLCSRBD2000R100	●	20	1.0	80	150	20	5
VQLCSRBD2000R200	●	20	2.0	80	150	20	5
VQLCSRBD2000R250	★	20	2.5	80	150	20	5
VQLCSRBD2000R300	●	20	3.0	80	150	20	5
VQLCSRBD2000R400	★	20	4.0	80	150	20	5
VQLCSRBD2000R500	●	20	5.0	80	150	20	5
VQLCSRBD2000R600	★	20	6.0	80	150	20	5

2/2

1. SMART MIRACLE coating has very low electrical conductivity; therefore, an electrical contact type of tool setter may not work.
When measuring the tool length, please use a mechanical contact type or a laser tool setter.



VQLCSRB

RECOMMENDED CUTTING CONDITIONS

SIDE MILLING

Material	DC	Vc	n	Vf	ap	ae	hm	h max	
P Carbon steel, Alloy steel, Mild steel	6	180	9500	1600	24	0.6	0.008	0.015	
	8	180	7200	1600	32	0.8	0.010	0.020	
	10	180	5700	1500	40	1.0	0.012	0.023	
	12	180	4800	1500	48	1.2	0.015	0.028	
	16	180	3600	1300	64	1.6	0.017	0.033	
	20	180	2900	1100	80	2.0	0.018	0.035	
	Pre-hardened steel, Alloy tool steel	6	160	8500	1200	24	0.6	0.007	0.013
		8	160	6400	1300	32	0.8	0.009	0.018
		10	160	5100	1200	40	1.0	0.011	0.022
		12	160	4200	1200	48	1.2	0.013	0.025
16		160	3200	1000	64	1.6	0.015	0.028	
M Austenitic, Ferritic and martensitic stainless steel,	6	100	5300	800	24	0.3	0.005	0.010	
	8	100	4000	800	32	0.4	0.006	0.013	
	10	100	3200	700	40	0.5	0.008	0.015	
	12	100	2700	700	48	0.6	0.008	0.017	
	16	100	2100	600	64	0.8	0.010	0.019	
S Titanium alloy	6	100	1600	500	80	1.0	0.011	0.021	
	M Hardened stainless steel, Cobalt chromium alloy	6	90	4800	700	24	0.3	0.005	0.010
		8	90	3600	700	32	0.4	0.006	0.013
		10	90	2900	700	40	0.5	0.008	0.015
		12	90	2400	600	48	0.6	0.008	0.016
16		90	1800	500	64	0.8	0.009	0.019	
N Copper, Copper alloy	20	90	1400	400	80	1.0	0.010	0.019	
	6	200	10600	1800	24	0.6	0.008	0.015	
	8	200	8000	1800	32	0.8	0.011	0.020	
	10	200	6400	1600	40	1.0	0.012	0.022	
	12	200	5300	1600	48	1.2	0.014	0.027	
S Heat resistant alloy	16	200	4000	1400	64	1.6	0.017	0.032	
	20	200	3200	1300	80	2.0	0.019	0.037	
	6	30	1600	100	24	0.12	0.002	0.003	
	8	30	1200	100	32	0.16	0.002	0.004	
	10	30	1000	100	40	0.20	0.003	0.005	
	12	30	800	100	48	0.24	0.003	0.005	
16	30	600	80	64	0.32	0.003	0.006		
20	30	500	80	80	0.40	0.003	0.007		

1/1

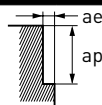

1. SMART MIRACLE coating has very low electrical conductivity; therefore, an electrical contact type of tool setter may not work. When measuring the tool length, please use a mechanical contact type or a laser tool setter.
2. The irregular pitch flute end mill has a larger effect on controlling vibration when compared to standard end mills. However, if the rigidity of the machine or the workpiece material installation is poor, vibration or abnormal sounds can occur. In that case, please adjust the revolution, feed rate and depth of cut.
3. The revolution and feed rate can be increased with a smaller depth of cut.
4. For machining stainless steel, titanium alloys and heat resistant alloys, the use of water-soluble coolant is effective.

VQELCSRB



CORNER RADIUS, EXTRA LONG CUT LENGTH, 5 FLUTE, IRREGULAR PITCH FLUTES, CHIPBREAKER

P M N S

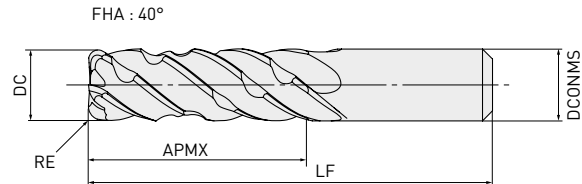

RE ≤ 0.3 RE ≥ 0.5

±0.015 ±0.020



DC ≤ 12 DC > 12

0 0
- 0.030 - 0.040



DCONMS = 6 DCONMS = 8, 10 DCONMS = 12 DCONMS = 16 DCONMS = 20

0 0 0 0 0
- 0.005 - 0.006 - 0.008 - 0.011 - 0.013

- Chipbreaker type end mill for efficient chip breaking capabilities that also provides good surface finishes.
- A high rigidity SMART MIRACLE vibration damping end mill for high efficiency trochoidal milling.

Order number	Stock	DC	RE	APMX	LF	DCONMS	ZEFP
VQELCSRBD0600R010	★	6	0.1	30	80	6	5
VQELCSRBD0600R020	★	6	0.2	30	80	6	5
VQELCSRBD0600R030	●	6	0.3	30	80	6	5
VQELCSRBD0600R050	●	6	0.5	30	80	6	5
VQELCSRBD0600R100	●	6	1.0	30	80	6	5
VQELCSRBD0800R020	★	8	0.2	40	100	8	5
VQELCSRBD0800R030	●	8	0.3	40	100	8	5
VQELCSRBD0800R050	●	8	0.5	40	100	8	5
VQELCSRBD0800R100	●	8	1.0	40	100	8	5
VQELCSRBD0800R150	●	8	1.5	40	100	8	5
VQELCSRBD0800R200	★	8	2.0	40	100	8	5
VQELCSRBD1000R020	★	10	0.2	50	110	10	5
VQELCSRBD1000R030	★	10	0.3	50	110	10	5
VQELCSRBD1000R050	●	10	0.5	50	110	10	5
VQELCSRBD1000R100	●	10	1.0	50	110	10	5
VQELCSRBD1000R150	●	10	1.5	50	110	10	5
VQELCSRBD1000R200	●	10	2.0	50	110	10	5

1/2

1. SMART MIRACLE coating has very low electrical conductivity; therefore, an electrical contact type of tool setter may not work. When measuring the tool length, please use a mechanical contact type or a laser tool setter.



● : Inventory maintained. ★ : Inventory maintained in Japan.

VQELCSRB – CORNER RADIUS, EXTRA LONG CUT LENGTH, 5 FLUTE, IRREGULAR PITCH FLUTES, CHIPBREAKER

Order number	Stock	DC	RE	APMX	LF	DCONMS	ZEFP
VQELCSRBD1000R250	★	10	2.5	50	110	10	5
VQELCSRBD1200R050	●	12	0.5	60	125	12	5
VQELCSRBD1200R100	●	12	1.0	60	125	12	5
VQELCSRBD1200R150	●	12	1.5	60	125	12	5
VQELCSRBD1200R200	●	12	2.0	60	125	12	5
VQELCSRBD1200R250	★	12	2.5	60	125	12	5
VQELCSRBD1200R300	●	12	3.0	60	125	12	5
VQELCSRBD1600R050	★	16	0.5	80	150	16	5
VQELCSRBD1600R100	●	16	1.0	80	150	16	5
VQELCSRBD1600R200	●	16	2.0	80	150	16	5
VQELCSRBD1600R250	★	16	2.5	80	150	16	5
VQELCSRBD1600R300	●	16	3.0	80	150	16	5
VQELCSRBD1600R400	★	16	4.0	80	150	16	5
VQELCSRBD1600R500	●	16	5.0	80	150	16	5
VQELCSRBD1600R600	★	16	6.0	80	150	16	5
VQELCSRBD2000R050	★	20	0.5	100	170	20	5
VQELCSRBD2000R100	●	20	1.0	100	170	20	5
VQELCSRBD2000R200	●	20	2.0	100	170	20	5
VQELCSRBD2000R250	★	20	2.5	100	170	20	5
VQELCSRBD2000R300	●	20	3.0	100	170	20	5
VQELCSRBD2000R400	★	20	4.0	100	170	20	5
VQELCSRBD2000R500	●	20	5.0	100	170	20	5
VQELCSRBD2000R600	★	20	6.0	100	170	20	5

2/2

1. SMART MIRACLE coating has very low electrical conductivity; therefore, an electrical contact type of tool setter may not work. When measuring the tool length, please use a mechanical contact type or a laser tool setter.



VQELCSRB

RECOMMENDED CUTTING CONDITIONS

SIDE MILLING

Material	DC	Vc	n	Vf	ap	ae	hm	h max	
P Carbon steel, Alloy steel, Mild steel	6	160	8500	1400	30	0.5	0.007	0.013	
	8	160	6400	1400	40	0.6	0.009	0.018	
	10	160	5100	1300	50	0.8	0.011	0.021	
	12	160	4200	1300	60	0.9	0.013	0.025	
	16	160	3200	1100	80	1.2	0.014	0.028	
	20	160	2500	950	100	1.5	0.016	0.031	
	Pre-hardened steel, Alloy tool steel	6	150	8000	1100	30	0.5	0.006	0.011
		8	150	6000	1200	40	0.6	0.008	0.016
		10	150	4800	1100	50	0.8	0.009	0.018
		12	150	4000	1100	60	0.9	0.011	0.022
16		150	3000	950	80	1.2	0.013	0.026	
M Austenitic, Ferritic and martensitic stainless steel,	6	90	4800	700	30	0.2	0.004	0.009	
	8	90	3600	700	40	0.3	0.006	0.012	
	10	90	2900	600	50	0.4	0.006	0.012	
	12	90	2400	600	60	0.5	0.008	0.015	
	16	90	1800	500	80	0.6	0.008	0.017	
S Titanium alloy	20	90	1400	400	100	0.8	0.009	0.017	
	M Hardened stainless steel, Cobalt chromium alloy	6	80	4200	600	30	0.2	0.004	0.009
		8	80	3200	600	40	0.3	0.006	0.011
10		80	2500	600	50	0.4	0.007	0.014	
12		80	2100	500	60	0.5	0.007	0.014	
16		80	1600	400	80	0.6	0.008	0.015	
N Copper, Copper alloy	20	80	1300	350	100	0.8	0.008	0.016	
	6	180	9500	1600	30	0.5	0.007	0.014	
	8	180	7200	1600	40	0.6	0.009	0.018	
	10	180	5700	1500	50	0.8	0.011	0.021	
	12	180	4800	1500	60	0.9	0.013	0.025	
S Heat resistant alloy	16	180	3600	1300	80	1.2	0.015	0.029	
	20	180	2900	1200	100	1.5	0.017	0.033	
	6	25	1300	90	30	0.10	0.001	0.003	
	8	25	1000	90	40	0.12	0.002	0.003	
	10	25	800	90	50	0.16	0.002	0.004	
	12	25	700	80	60	0.18	0.002	0.004	
16	25	500	70	80	0.24	0.003	0.005		
20	25	400	70	100	0.30	0.003	0.007		

1/1

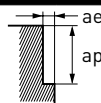

1. SMART MIRACLE coating has very low electrical conductivity; therefore, an electrical contact type of tool setter may not work. When measuring the tool length, please use a mechanical contact type or a laser tool setter.
2. The irregular pitch flute end mill has a larger effect on controlling vibration when compared to standard end mills. However, if the rigidity of the machine or the workpiece material installation is poor, vibration or abnormal sounds can occur. In that case, please adjust the revolution, feed rate and depth of cut.
3. The revolution and feed rate can be increased with a smaller depth of cut.
4. For machining stainless steel, titanium alloys and heat resistant alloys, the use of water-soluble coolant is effective.

VQ6MHVRBCH



CORNER RADIUS END MILL, MEDIUM CUT LENGTH, IRREGULAR HELIX FLUTES, 6 FLUTE WITH MULTIPLE INTERNAL THROUGH COOLANT HOLES

M S

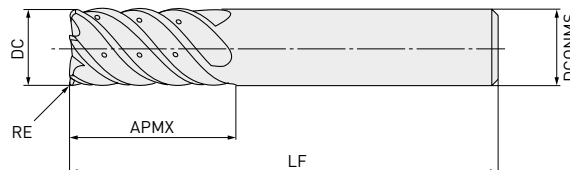

$0.5 \leq RE \leq 4$

± 0.015



DC ≤ 12	DC > 12
0	0
-0.020	-0.030



DCONMS = 10	DCONMS = 12	DCONMS = 16	DCONMS = 20
0	0	0	0
-0.009	-0.011	-0.011	-0.013

- Multiple coolant channels ensure improved chip removal for reliable machining of difficult-to-cut materials.

Order number	Stock	DC	RE	APMX	LF	DCONMS	ZEFP
VQ6MHVRBCHD1000R050	●	10	0.5	22	70	10	
VQ6MHVRBCHD1000R100	●	10	1	22	70	10	
VQ6MHVRBCHD1200R050	●	12	0.5	26	75	12	
VQ6MHVRBCHD1200R100	●	12	1	26	75	12	
VQ6MHVRBCHD1600R100	●	16	1	32	90	16	
VQ6MHVRBCHD1600R300	●	16	3	32	90	16	6
VQ6MHVRBCHD1600R400	●	16	4	32	90	16	
VQ6MHVRBCHD2000R100	●	20	1	38	100	20	
VQ6MHVRBCHD2000R300	●	20	3	38	100	20	
VQ6MHVRBCHD2000R400	●	20	4	38	100	20	

1/1



VQ6MHVRBCH

RECOMMENDED CUTTING CONDITIONS

SHOULDER MILLING

Material	DC	n	Vf
M Austenitic stainless steel (<200HB), Titanium alloy	10	4800	2000
	12	4000	2000
	16	3000	1600
	20	2400	1400
S Heat resistant alloy	10	1300	260
	12	1100	230
	16	800	180
	20	640	150

1/1

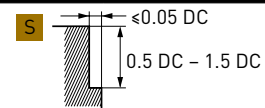
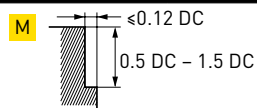

TROCHOIDAL MILLING

Material	DC	n	Vf
M Austenitic stainless steel (<200HB), Titanium alloy	10	4800	1400
	12	4000	1200
	16	3000	1100
	20	2400	900

1/1

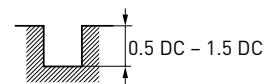
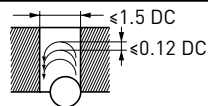

1. If the depth of cut is shallow, the revolution and feed rate can be increased.
2. The irregular helix flute end mill has a larger effect on controlling vibration when compared to standard end mills. However, if the rigidity of the machine or the workpiece installation is very low, then vibration can occur. In this case, please reduce the revolution and feed rate proportionately.

VQMHRB

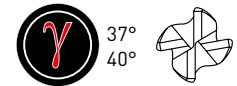

CORNER RADIUS END MILL, MEDIUM CUT LENGTH, IRREGULAR HELIX FLUTES, 4 FLUTE

P M N S



0.2 <R 6.35

±0.015



DC <12 DC >12

0 0
-0.02 -0.03



4 < D4 < 6 8 < D4 < 10 12 < D4 < 16 D4 = 12

0 0 0 0
-0.008 -0.009 -0.011 -0.013

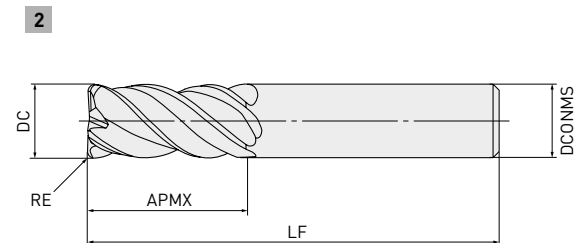
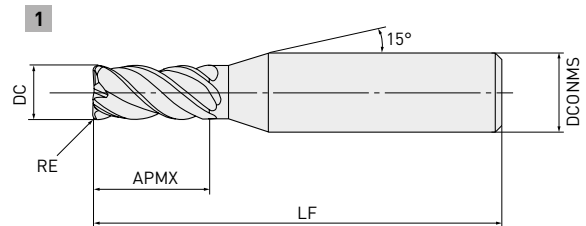

- VQ vibration control end mills for reduced chattering, a stable performance on difficult-to-cut materials and long overhang applications.

Order number	Stock	DC	RE	APMX	LF	DCONMS	ZEFP	Type
VQMHRBD0200R020	●	2	0.2	4	45	4	4	1
VQMHRBD0200R030	●	2	0.3	4	45	4	4	1
VQMHRBD0300R020	●	3	0.2	8	45	6	4	1
VQMHRBD0300R030	●	3	0.3	8	45	6	4	1
VQMHRBD0300R050	●	3	0.5	8	45	6	4	1
VQMHRBD0400R020	●	4	0.2	11	45	6	4	1
VQMHRBD0400R030	●	4	0.3	11	45	6	4	1
VQMHRBD0400R050	●	4	0.5	11	45	6	4	1
VQMHRBD0500R020	●	5	0.2	13	50	6	4	1
VQMHRBD0500R030	●	5	0.3	13	50	6	4	1
VQMHRBD0500R050	●	5	0.5	13	50	6	4	1
VQMHRBD0500R100	●	5	1	13	50	6	4	1
VQMHRBD0600R030	●	6	0.3	13	50	6	4	2
VQMHRBD0600R050	●	6	0.5	13	50	6	4	2
VQMHRBD0600R100	●	6	1	13	50	6	4	2
VQMHRBD0800R030	●	8	0.3	19	60	8	4	2
VQMHRBD0800R050	●	8	0.5	19	60	8	4	2

1/2

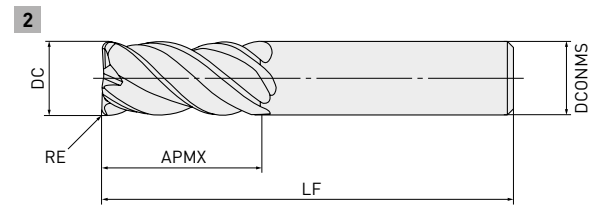
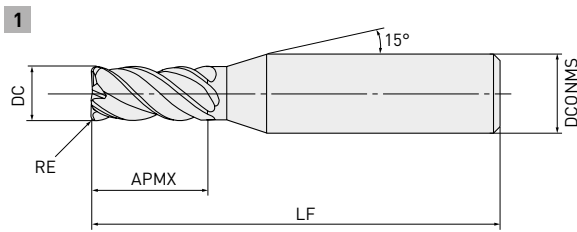
VQMHVRB – CORNER RADIUS END MILL, MEDIUM CUT LENGTH, IRREGULAR HELIX FLUTES, 4 FLUTE

Order number	Stock	DC	RE	APMX	LF	DCONMS	ZEFP	Type
VQMHVRBD0800R100	●	8	1	19	60	8	4	2
VQMHVRBD0800R150	●	8	1.5	19	60	8	4	2
VQMHVRBD1000R030	●	10	0.3	22	70	10	4	2
VQMHVRBD1000R050	●	10	0.5	22	70	10	4	2
VQMHVRBD1000R100	●	10	1	22	70	10	4	2
VQMHVRBD1000R150	●	10	1.5	22	70	10	4	2
VQMHVRBD1000R200	●	10	2	22	70	10	4	2
VQMHVRBD1200R050	●	12	0.5	26	75	12	4	2
VQMHVRBD1200R100	●	12	1	26	75	12	4	2
VQMHVRBD1200R150	●	12	1.5	26	75	12	4	2
VQMHVRBD1200R200	●	12	2	26	75	12	4	2
VQMHVRBD1200R250	●	12	2.5	26	75	12	4	2
VQMHVRBD1200R300	●	12	3	26	75	12	4	2
VQMHVRBD1600R100	●	16	1	35	90	16	4	2
VQMHVRBD1600R150	●	16	1.5	35	90	16	4	2
VQMHVRBD1600R200	●	16	2	35	90	16	4	2
VQMHVRBD1600R250	●	16	2.5	35	90	16	4	2
VQMHVRBD1600R300	●	16	3	35	90	16	4	2
VQMHVRBD1600R400	●	16	4	35	90	16	4	2
VQMHVRBD1600R500	●	16	5	35	90	16	4	2
VQMHVRBD2000R100	●	20	1	45	110	20	4	2
VQMHVRBD2000R150	●	20	1.5	45	110	20	4	2
VQMHVRBD2000R200	●	20	2	45	110	20	4	2
VQMHVRBD2000R250	●	20	2.5	45	110	20	4	2
VQMHVRBD2000R300	●	20	3	45	110	20	4	2
VQMHVRBD2000R400	●	20	4	45	110	20	4	2
VQMHVRBD2000R500	●	20	5	45	110	20	4	2
VQMHVRBD2000R635	●	20	6.35	45	110	20	4	2

2/2

VQMHV RB

RECOMMENDED CUTTING CONDITIONS

SHOULDER MILLING

HIGH EFFICIENCY CUTTING CONDITIONS

Material	DC	n	Vf	ap	ae
Carbon steel, Alloy steel (180 – 280 HB), Cast iron	2	24000	2400	3	0.6
	3	16000	2600	4.5	0.9
	4	12000	2600	6	1.2
	5	9500	2500	7.5	1.5
	6	8000	2600	9	1.8
	8	6000	2500	12	2.4
	10	4800	2300	15	3
	12	4000	1900	18	3.6
	16	3000	1600	24	4.8
	20	2400	1300	30	6
Carbon steel, Alloy steel, Alloy tool steel	25	1900	1100	37	7.5
	2	19000	1100	3	0.6
	3	13000	1200	4.5	0.9
	4	9500	1300	6	1.2
	5	7600	1300	7.5	1.5
	6	6400	1300	9	1.8
	8	4800	1300	12	2.4
	10	3800	1200	15	3
	12	3200	1200	18	3.6
	16	2400	960	24	4.8
Austenitic, Ferritic and martensitic stainless steel, Titanium alloy	20	1900	760	30	6
	25	1500	600	37	7.5
	2	16000	830	3	0.6
	3	11000	880	4.5	0.9
	4	8000	900	6	1.2
	5	6400	900	7.5	1.5
	6	5300	1100	9	1.8
	8	4000	1200	12	2.4
	10	3200	1300	15	3
	12	2700	1200	18	3.6
Hardened stainless steel, Cobalt chromium alloy	16	2000	960	24	4.8
	20	1600	770	30	6
	25	1300	620	37	7.5
	2	12000	720	3	0.4
	3	8000	770	4.5	0.6
	4	6000	790	6	0.8
	5	4800	810	7.5	1
	6	4000	800	9	1.2
	8	3000	840	12	1.6
	10	2400	770	15	2
12	2000	720	18	2.4	
16	1500	600	24	3.2	
20	1200	480	30	4	
25	950	380	37	5	

VQMHVRB – SHOULDER MILLING – HIGH EFFICIENCY CUTTING CONDITIONS

Material	DC	n	Vf	ap	ae
N Copper, Copper alloy	2	29000	2900	3	0.6
	3	19000	3000	4.5	0.9
	4	14000	3100	6	1.2
	5	11000	2900	7.5	1.5
	6	9500	3000	9	1.8
	8	7200	3000	12	2.4
	10	5700	2700	15	3
	12	4800	2300	18	3.6
	16	3600	1900	24	4.8
	20	2900	1600	30	6
S Heat resistant alloy	25	2300	1300	37	7.5
	2	6400	230	3	0.2
	3	4200	240	4.5	0.3
	4	3200	240	6	0.4
	5	2500	240	7.5	0.5
	6	2100	250	9	0.6
	8	1600	260	12	0.8
	10	1300	290	15	1
	12	1100	280	18	1.2
	16	800	200	24	1.6
20	640	160	30	2	
25	510	130	37.5	2.5	

2/2



VQMHRB

SHOULDER MILLING

GENERAL PURPOSE CUTTING CONDITIONS

Material	DC	n	Vf	ap	ae
P Carbon steel, Alloy steel, Mild steel	2	19000	1300	3	0.6
	3	13000	1400	4.5	0.9
	4	9500	1400	6	1.2
	5	7600	1300	7.5	1.5
	6	6400	1400	9	1.8
	8	4800	1300	12	2.4
	10	3800	1200	15	3
	12	3200	1000	18	3.6
	16	2400	860	24	4.8
	20	1900	680	30	6
P Pre-hardened steel, Carbon steel, Alloy steel, Alloy tool steel	25	1500	390	37.5	7.5
	2	16000	630	3	0.6
	3	11000	700	4.5	0.9
	4	8000	700	6	1.2
	5	6400	710	7.5	1.5
	6	5300	700	9	1.8
	8	4000	740	12	2.4
	10	3200	680	15	3
	12	2700	640	18	3.6
	16	2000	530	24	4.8
M Austenitic, Ferritic and martensitic stainless steel, Titanium alloy	20	1600	420	30	6
	25	1300	340	37.5	7.5
	2	13000	450	1.5	0.2
	3	8500	450	2.25	0.3
	4	6400	470	3	0.6
	5	5100	470	4.5	0.9
	6	4200	580	6	1.2
	8	3200	630	7.5	1.5
	10	2500	660	9	1.8
	12	2100	610	12	2.4
S Hardened stainless steel, Cobalt chromium alloy	16	1600	510	15	3
	20	1300	410	18	3.6
	25	1000	210	24	4.8
	2	11000	440	3	0.4
	3	7400	470	4.5	0.6
	4	5600	490	6	0.8
M Hardened stainless steel, Cobalt chromium alloy	5	4500	500	7.5	1
	6	3700	490	9	1.2
	8	2800	520	12	1.6
	10	2200	460	15	2
	12	1900	450	18	2.4
	16	1400	370	24	3.2
	20	1100	290	30	4
	25	890	230	37.5	5

VQMHVRB – SHOULDER MILLING – GENERAL PURPOSE CUTTING CONDITIONS

Material	DC	n	Vf	ap	ae
N Copper, Copper alloy	2	22000	1500	3	0.6
	3	15000	1600	4.5	0.9
	4	11000	1600	6	1.2
	5	8900	1500	7.5	1.5
	6	7400	1600	9	1.8
	8	5600	1600	12	2.4
	10	4500	1400	15	3
	12	3700	1200	18	3.6
	16	2800	1000	24	4.8
	20	2200	780	30	6
	25	1800	670	37.5	7.5
S Heat resistant alloy	2	4800	110	3	0.2
	3	3200	120	4.5	0.3
	4	2400	120	6	0.4
	5	1900	120	7.5	0.5
	6	1600	130	9	0.6
	8	1200	130	12	0.8
	10	950	140	15	1
	12	800	140	18	1.2
	16	600	100	24	1.6
	20	480	81	30	2
	25	380	64	37.5	2.5

2/2

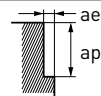

1. SMART MIRACLE coating has very low electrical conductivity; therefore, an electrical contact type of tool setter may not work. When measuring the tool length, please use a mechanical contact type or a laser tool setter.
2. Effective machining of stainless steel, titanium alloys and heat-resistant alloys etc. can be achieved with the use of emulsion coolant.
3. Chattering can still occur if the machine rigidity and clamping method are insufficient. In these cases the feed and speed should be reduced proportionately.
4. When the depth of cut is smaller than shown the revolution and feed rate can be increased.

VQMHRB

SLOTTING

HIGH EFFICIENCY CUTTING CONDITIONS

Material	DC	n	Vf	ap
Carbon steel, Alloy steel, Mild steel	2	24000	1200	2
	3	16000	1500	3
	4	12000	1900	4
	5	9500	1900	5
	6	8000	1900	6
	8	6000	1700	8
	10	4800	1500	10
	12	4000	1300	12
	16	3000	1100	12
	20	2400	860	12
Pre-hardened steel, Carbon steel, Alloy steel, Alloy tool steel	25	1900	760	12
	2	19000	610	2
	3	13000	730	3
	4	9500	910	4
	5	7600	910	5
	6	6400	1000	6
	8	4800	960	8
	10	3800	840	10
	12	3200	770	12
	16	2400	670	12
Austenitic, Ferritic and martensitic stainless steel, Titanium alloy	20	1900	530	12
	25	1500	420	12
	2	16000	640	2
	3	11000	660	3
	4	8000	700	4
	5	6400	720	5
	6	5300	740	6
	8	4000	800	8
	10	3200	900	10
	12	2700	860	12
Hardened stainless steel, Cobalt chromium alloy	16	2000	640	12
	20	1600	510	12
	25	1300	420	12
	2	9500	300	1
	3	6400	360	1.5
	4	4800	460	2
5	3800	460	2.5	
6	3200	510	3	
8	2400	480	4	
10	1900	420	5	
12	1600	380	6	
16	1200	340	8	
20	950	270	10	
25	760	210	12	

VQMHVRB – SLOTTING – HIGH EFFICIENCY CUTTING CONDITIONS

Material	DC	n	Vf	ap
N Copper, Copper alloy	2	29000	1500	2
	3	19000	1700	3
	4	14000	2200	4
	5	11000	2200	5
	6	9500	2300	6
	8	7200	2000	8
	10	5700	1800	10
	12	4800	1500	12
	16	3600	1300	12
	20	2900	1000	12
S Heat resistant alloy	25	2300	920	12
	2	4800	130	0.6
	3	3200	150	0.9
	4	2400	170	1.2
	5	1900	170	1.5
	6	1600	180	1.8
	8	1200	190	2.4
	10	950	210	3
	12	800	200	3.6
	16	600	150	4.8
20	480	120	6	
25	380	100	7.5	

2/2

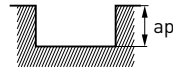

VQMHRB

SLOTTING

GENERAL PURPOSE CUTTING CONDITIONS

Material	DC	n	Vf	ap	
P Carbon steel, Alloy steel, Mild steel	2	16000	550	2	
	3	11000	670	3	
	4	8000	840	4	
	5	6400	840	5	
	6	5300	840	6	
	8	4000	740	8	
	10	3200	680	10	
	12	2700	570	12	
	16	2000	480	12	
	20	1600	380	12	
	25	1300	340	12	
	Pre-hardened steel, Carbon steel, Alloy steel, Alloy tool steel	2	13000	270	2
		3	8500	310	3
		4	6400	410	4
5		5100	400	5	
6		4200	440	6	
8		3200	420	8	
10		2500	360	10	
12		2100	330	12	
16		1600	300	12	
20		1300	240	12	
25		1000	180	12	
M Austenitic, Ferritic and martensitic stainless steel, Titanium alloy	2	9500	250	2	
	3	6400	250	3	
	4	4800	280	4	
	5	3800	280	5	
	6	3200	300	6	
	8	2400	320	8	
	10	1900	350	10	
	12	1600	340	12	
	16	1200	250	12	
	20	950	200	12	
25	760	160	12		
M Hardened stainless steel, Cobalt chromium alloy	2	8000	170	1	
	3	5300	200	1.5	
	4	4000	250	2	
	5	3200	250	2.5	
	6	2700	290	3	
	8	2000	260	4	
	10	1600	230	5	
	12	1300	210	6	
	16	990	180	8	
	20	800	150	10	
25	640	120	12		

VQMHRB – SLOTTING – GENERAL PURPOSE CUTTING CONDITIONS

Material	DC	n	Vf	ap
N Copper, Copper alloy	2	19000	650	2
	3	13000	790	3
	4	9500	1000	4
	5	7600	1000	5
	6	6400	1000	6
	8	4800	890	8
	10	3800	800	10
	12	3200	680	12
	16	2400	570	12
	20	1900	450	12
S Heat resistant alloy	2	4000	74	0.6
	3	2700	86	0.9
	4	2000	93	1.2
	5	1600	95	1.5
	6	1300	96	1.8
	8	990	100	2.4
	10	800	120	3
	12	660	110	3.6
	16	500	84	4.8
	20	400	68	6
	25	320	50	7.5

2/2

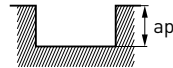

1. SMART MIRACLE coating has very low electrical conductivity; therefore, an electrical contact type of tool setter may not work. When measuring the tool length, please use a mechanical contact type or a laser tool setter.
2. Effective machining of stainless steel, titanium alloys and heat-resistant alloys etc. can be achieved with the use of emulsion coolant.
3. Chattering can still occur if the machine rigidity and clamping method are insufficient. In these cases the feed and speed should be reduced proportionately.
4. When the depth of cut is smaller than shown the revolution and feed rate can be increased.

VQMHRBF

37°
40°

CORNER RADIUS END MILL, MEDIUM CUT LENGTH, 4 FLUTE, IRREGULAR HELIX FLUTES

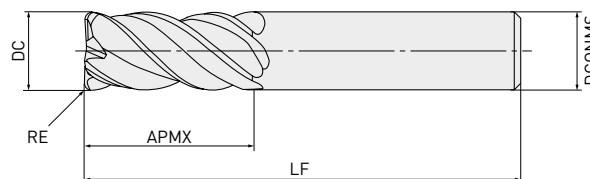

0.3 < R < 2

±0.015



DC < 12 DC > 12

0 0
-0.02 -0.03

D4 = 6 8 < D4 < 10 12 < D4 < 16

0 0 0
-0.008 -0.009 -0.011

- 4 flute irregular helix end mill for reduced vibration when machining difficult-to-cut materials.
- Ideal for finishing.

Order number	Stock	DC	RE	APMX	LF	DCONMS	ZEFP
VQMHRBFD0600R030	●	6	0.3	13	50	6	4
VQMHRBFD0600R050	●	6	0.5	13	50	6	4
VQMHRBFD0600R100	●	6	1	13	50	6	4
VQMHRBFD0800R050	●	8	0.5	19	60	8	4
VQMHRBFD0800R100	●	8	1	19	60	8	4
VQMHRBFD1000R030	●	10	0.3	22	70	10	4
VQMHRBFD1000R050	●	10	0.5	22	70	10	4
VQMHRBFD1000R100	●	10	1	22	70	10	4
VQMHRBFD1000R200	●	10	2	22	70	10	4
VQMHRBFD1200R100	●	12	1	26	75	12	4
VQMHRBFD1200R200	●	12	2	26	75	12	4
VQMHRBFD1200R300	●	12	3	26	75	12	4
VQMHRBFD1600R100	●	16	1	35	90	16	4
VQMHRBFD1600R200	●	16	2	35	90	16	4

1/1



VQMHVRF

RECOMMENDED CUTTING CONDITIONS

SHOULDER MILLING

Material	DC	n	Vf	ap	ae
P Carbon steel, Alloy steel, Mild steel	6	8000	2600	9	0.3
	8	6000	2500	12	0.4
	10	4800	2300	15	0.5
	12	4000	1900	18	0.6
	16	3000	1600	24	0.8
P Pre-hardened steel, Carbon steel, Alloy steel, Alloy tool steel	6	6400	1300	9	0.3
	8	4800	1300	12	0.4
	10	3800	1200	15	0.5
	12	3200	1200	18	0.6
	16	2400	960	24	0.8
M Hardened stainless steel, Cobalt chromium alloy	6	4000	800	9	0.3
	8	3000	840	12	0.4
	10	2400	770	15	0.5
	12	2000	720	18	0.6
	16	1500	600	24	0.8
N Copper, Copper alloy	6	9500	3000	9	0.3
	8	7200	3000	12	0.4
	10	5700	2700	15	0.5
	12	4800	2300	18	0.6
	16	3600	1900	24	0.8
S Heat resistant alloy	6	2100	250	9	0.1
	8	1600	260	12	0.2
	10	1300	290	15	0.3
	12	1100	280	18	0.3
	16	800	200	24	0.4

1/1

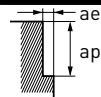

VQMHRBF

FACE MILLING

Material	DC	n	Vf	ap	ae
P Carbon steel, Alloy steel, Mild steel	6	5800	1400	0.3	4.8
	8	4400	1200	0.4	6.4
	10	3500	1100	0.5	8
	12	2900	930	0.6	9.6
	16	2200	790	0.8	12.8
Pre-hardened steel, Carbon steel, Alloy steel, Alloy tool steel	6	4800	770	0.3	4.8
	8	3600	720	0.4	6.4
	10	2900	640	0.5	8
	12	2400	580	0.6	9.6
	16	1800	500	0.8	12.8
M Hardened stainless steel, Cobalt chromium alloy	6	2900	460	0.3	4.8
	8	2200	440	0.4	6.4
	10	1800	400	0.5	8
	12	1500	360	0.6	9.6
	16	1100	310	0.8	12.8
N Copper, Copper alloy	6	6900	1700	0.3	4.8
	8	5200	1500	0.4	6.4
	10	4100	1300	0.5	8
	12	3400	1100	0.6	9.6
	16	2600	940	0.8	12.8
S Heat resistant alloy	6	1600	180	0.18	4.8
	8	1200	190	0.24	6.4
	10	950	210	0.3	8
	12	800	200	0.36	9.6
	16	600	150	0.48	12.8

1/1

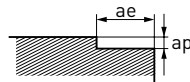

1. SMART MIRACLE coating has very low electrical conductivity; therefore, an electrical contact type of tool setter may not work. When measuring the tool length, please use a mechanical contact type or a laser tool setter.
2. Effective machining of stainless steel, titanium alloys and heat-resistant alloys etc. can be achieved with the use of emulsion coolant.
3. Chattering can still occur if the machine rigidity and clamping method are insufficient. In these cases the feed and speed should be reduced proportionately.
4. When the depth of cut is smaller than shown the revolution and feed rate can be increased.

VQHVRB

43°
45°

CORNER RADIUS, SHORT CUT LENGTH, IRREGULAR HELIX FLUTES, 4 FLUTE

S

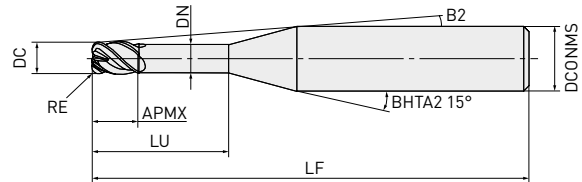
 $0.1 \leq RE \leq 1$

+0.01

 $1 \leq DC \leq 4$

0

-0.020



DCONMS=6

0

-0.005

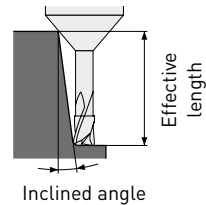
Effective length
for inclined angle

- SMART MIRACLE corner radius end mill for high feed rates and efficient machining.

Order number	Stock	DC	RE	APMX	LF	LU	DN	B2	DCONMS	ZEFP
VQHVRBD0100R01N080	●	1	0.1	1	50	8	0.94	8.2°	6	4
VQHVRBD0100R01N120	●	1	0.1	1	55	12	0.94	6.7°	6	4
VQHVRBD0200R02N120	●	2	0.2	2	55	12	1.9	5.9°	6	4
VQHVRBD0200R02N160	●	2	0.2	2	60	16	1.9	4.9°	6	4
VQHVRBD0300R05N100	●	3	0.5	3	55	10	2.9	5.6°	6	4
VQHVRBD0300R05N180	●	3	0.5	3	60	18	2.9	3.7°	6	4
VQHVRBD0400R10N120	●	4	1	4	55	12	3.9	3.9°	6	4
VQHVRBD0400R10N200	●	4	1	4	60	20	3.9	2.5°	6	4

1/1



VQHVRB

RECOMMENDED CUTTING CONDITIONS

Material	DC	LU	n	Vc	Vf	ap	ae
Titanium alloy	1	8	2500	8	500	0.030	0.1
	1	12	2500	8	350	0.030	0.1
	2	12	4800	30	600	0.075	0.3
	2	16	4800	30	340	0.075	0.3
	3	10	8500	80	2400	0.190	1.3
	3	18	8500	80	2000	0.190	1.3
	4	12	6400	80	2000	0.250	1.7
	4	20	6400	80	2000	0.250	1.7
Cobalt chromium alloy, Precipitation hardening stainless steel	1	8	2500	8	500	0.030	0.1
	1	12	2500	8	350	0.030	0.1
	2	12	4800	30	600	0.075	0.3
	2	16	4800	30	350	0.075	0.3
	3	10	6400	60	2200	0.170	1.3
	3	18	6400	60	1600	0.170	1.3
	4	12	4800	60	1800	0.220	1.7
	4	20	4800	60	1800	0.220	1.7

1/1

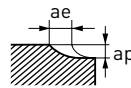

1. SMART MIRACLE coating has very low electrical conductivity; therefore, an electrical contact type of tool setter may not work.
When measuring the tool length, please use a mechanical contact type or a laser tool setter.
2. When machining titanium alloys, the use of water-soluble cutting fluid is effective.
3. If the depth of cut is smaller, the revolution and the feed rate can be increased.
4. The irregular helix flute end mill has a larger effect on controlling vibration when compared to standard end mills.
However, if the rigidity of the machine or the workpiece material installation is poor, vibration or abnormal sound can occur.
In this case, please reduce the revolution and the feed rate proportionately, or set a lower depth of cut.

VQFDRB



DUPLEX CORNER RADIUS END MILL FOR HIGH FEED CUTTING, 4 FLUTE

S

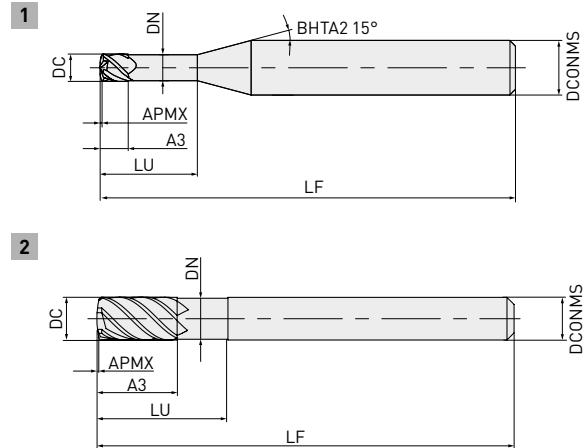

$1 \leq DC \leq 4$
0
-0.020



DCONMS=6
0
-0.005

- Duplex corner radius type allows a higher, more efficient feed rate.
- High feed cutting realised through the use of multiple flutes.

Order number	Stock	DC	RE1	APMX	LF	A3	LU	DN	DCONMS	ZEFP	RMPX	Multi-task radius part				Type
												S10	DCIN	RE2	RE3	
VQFDRBD0300N080	●	3	0.64	0.18	50	3	8	2.8	6	4	2.1	0.08	0.75	0.5	2	1
VQFDRBD0300N120	●	3	0.64	0.18	55	3	12	2.8	6	4	2.1	0.08	0.75	0.5	2	1
VQFDRBD0400N120	●	4	0.71	0.25	55	4	12	3.8	6	4	1.9	0.13	1	0.5	3	1
VQFDRBD0400N160	●	4	0.71	0.25	60	4	16	3.8	6	4	1.9	0.13	1	0.5	3	1
VQFDRBD0600N180	●	6	0.92	0.36	60	6	18	5.6	6	4	1.7	0.21	1.5	0.6	5	2

1/1

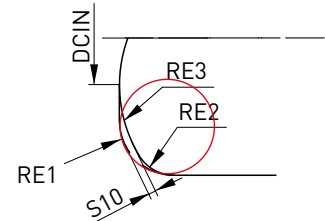

VQFDRB

RECOMMENDED CUTTING CONDITIONS

Material	DC	n	Vc	Vf	ap	ae
Titanium alloy	3	8500	80	2100	0.2	1.3
	4	6400	80	2200	0.2	1.7
	6	4200	80	1400	0.3	2.0
Cobalt chromium alloy, Precipitation hardening stainless steel	3	6400	60	3000	0.2	1.3
	4	4800	60	2700	0.2	1.7
	6	3200	60	2100	0.3	2.6
Heat resistant alloy	3	3200	30	770	0.2	0.6
	4	2400	30	770	0.2	0.8
	6	1600	30	520	0.3	1.3

1/1

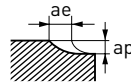

1. SMART MIRACLE coating has very low electrical conductivity; therefore, an electrical contact type of tool setter may not work.
When measuring the tool length, please use a mechanical contact type or a laser tool setter.
2. When machining titanium alloys, the use of water-soluble cutting fluid is effective.
3. If the depth of cut is smaller, the revolution and the feed rate can be increased.

VQJCS



END MILL, SEMI LONG CUT LENGTH (3 x DC), 5 FLUTE, IRREGULAR PITCH FLUTES, CHIPBREAKER

P **M** **N** **S**

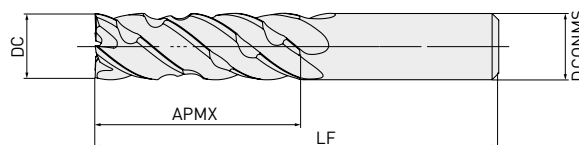

DC<12	DC>12
0	0
-0.030	-0.040



DCONMS=6	DCONMS=8, 10	DCONMS=12	DCONMS=16	DCONMS=20
0	0	0	0	0
-0.005	-0.006	-0.008	-0.011	-0.013

- Chipbreaker type end mill for efficient chip breaking capabilities that also provides good surface finishes.
- A high rigidity SMART MIRACLE vibration damping end mill for high efficiency trochoidal milling.

Order number	Stock	DC	APMX	LF	DCONMS	ZEFP
VQJCS0600	●	6	18	70	6	
VQJCS0800	●	8	24	80	8	
VQJCS1000	●	10	30	90	10	
VQJCS1200	●	12	36	100	12	5
VQJCS1600	●	16	48	110	16	
VQJCS2000	●	20	60	125	20	

1/1

1. If a flat is required on the tool for side clamping, please contact our Technical Department.



VQJCS

RECOMMENDED CUTTING CONDITIONS

SIDE MILLING

Material	DC	Vc	n	Vf	ap	ae	hm	h max	
P Carbon steel, Alloy steel, Mild steel	6	200	10600	1800	18	0.9	0.010	0.019	
	8	200	8000	1800	24	1.2	0.013	0.025	
	10	200	6400	1700	30	1.5	0.016	0.029	
	12	200	5300	1700	36	1.8	0.019	0.035	
	16	200	4000	1400	48	2.4	0.020	0.039	
	20	200	3200	1200	60	3.0	0.023	0.043	
	Pre-hardened steel, Carbon steel, Alloy steel, Alloy tool steel	6	180	9500	1500	18	0.9	0.009	0.017
		8	180	7200	1500	24	1.2	0.012	0.023
		10	180	5700	1400	30	1.5	0.015	0.028
		12	180	4800	1400	36	1.8	0.017	0.032
16		180	3600	1200	48	2.4	0.018	0.035	
M Austenitic, Ferritic and martensitic stainless steel,	6	120	6400	1000	18	0.45	0.006	0.012	
	8	120	4800	1000	24	0.6	0.008	0.016	
	10	120	3800	900	30	0.75	0.010	0.019	
S Titanium alloy	12	120	3200	800	36	0.9	0.011	0.021	
	16	120	2400	700	48	1.2	0.012	0.023	
	20	120	1900	600	60	1.5	0.013	0.026	
M Hardened stainless steel, Cobalt chromium alloy	6	100	5300	800	18	0.45	0.006	0.012	
	8	100	4000	800	24	0.6	0.008	0.016	
	10	100	3200	800	30	0.75	0.01	0.019	
	12	100	2700	700	36	0.9	0.011	0.021	
	16	100	2000	600	48	1.2	0.012	0.023	
N Copper, Copper alloy	20	100	1600	500	60	1.5	0.013	0.026	
	6	220	11700	2100	18	0.9	0.010	0.019	
	8	220	8800	2100	24	1.2	0.014	0.026	
	10	220	7000	1800	30	1.5	0.015	0.028	
	12	220	5800	1800	36	1.8	0.018	0.034	
S Heat resistant alloy	16	220	4400	1500	48	2.4	0.020	0.038	
	20	220	3500	1400	60	3.0	0.022	0.042	
	6	40	2100	200	18	0.18	0.002	0.004	
	8	40	1600	200	24	0.24	0.003	0.006	
	10	40	1300	200	30	0.3	0.003	0.007	
	12	40	1100	100	36	0.36	0.003	0.007	
	16	40	800	100	48	0.48	0.004	0.007	
	20	40	600	100	60	0.6	0.004	0.007	

1/1

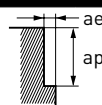

1. SMART MIRACLE coating has very low electrical conductivity; therefore, an electrical contact type of tool setter may not work. When measuring the tool length, please use a mechanical contact type or a laser tool setter.
2. The irregular pitch flute end mill has a larger effect on controlling vibration when compared to standard end mills. However, if the rigidity of the machine or the workpiece material installation is poor, vibration or abnormal sounds can occur. In that case, please adjust the revolution, feed rate and depth of cut.
3. The revolution and feed rate can be increased with a smaller depth of cut.
4. For stainless steel, titanium alloys and heat resistant alloys, the use of water-soluble coolant is effective.

VQLCS



END MILL, LONG CUT LENGTH (4 x DC), 5 FLUTE, IRREGULAR PITCH FLUTES, CHIPBREAKER

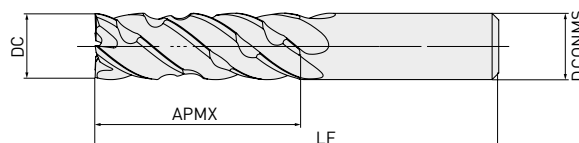

DC≤12	DC>12
0	0
-0.030	-0.040



DCONMS=6	DCONMS=8, 10	DCONMS=12	DCONMS=16	DCONMS=20
0	0	0	0	0
-0.005	-0.006	-0.008	-0.011	-0.013

- Chipbreaker type end mill for efficient chip breaking capabilities that also provides good surface finishes.
- A high rigidity SMART MIRACLE vibration damping end mill for high efficiency trochoidal milling.

Order number	Stock	DC	APMX	LF	DCONMS	ZEFP
VQLCSD0600	●	6	24	70	6	
VQLCSD0800	●	8	32	90	8	
VQLCSD1000	●	10	40	100	10	
VQLCSD1200	●	12	48	110	12	5
NEW VQLCSD1600	●	16	64	130	16	
NEW VQLCSD2000	●	20	80	150	20	

1/1

1. If a flat is required on the tool for side clamping, please contact our Technical Department.



VQLCS

RECOMMENDED CUTTING CONDITIONS

SIDE MILLING

Material	DC	Vc	n	Vf	ap	ae	hm	h max	
P Carbon steel, Alloy steel, Mild steel	6	180	9500	1600	24	0.6	0.008	0.015	
	8	180	7200	1600	32	0.8	0.010	0.020	
	10	180	5700	1500	40	1.0	0.012	0.023	
	12	180	4800	1500	48	1.2	0.015	0.028	
	16	180	3600	1300	64	1.6	0.017	0.033	
	20	180	2900	1100	80	2.0	0.018	0.035	
	Pre-hardened steel, Carbon steel, Alloy steel, Alloy tool steel	6	160	8500	1200	24	0.6	0.007	0.013
		8	160	6400	1300	32	0.8	0.009	0.018
		10	160	5100	1200	40	1.0	0.011	0.022
		12	160	4200	1200	48	1.2	0.013	0.025
16		160	3200	1000	64	1.6	0.015	0.028	
M Austenitic, Ferritic and martensitic stainless steel,	6	100	5300	800	24	0.3	0.005	0.010	
	8	100	4000	800	32	0.4	0.006	0.013	
	10	100	3200	700	40	0.5	0.008	0.015	
S Titanium alloy	12	100	2700	700	48	0.6	0.008	0.017	
	16	100	2100	600	64	0.8	0.010	0.019	
	20	100	1600	500	80	1.0	0.011	0.021	
M Hardened stainless steel, Cobalt chromium alloy	6	90	4800	700	24	0.3	0.005	0.010	
	8	90	3600	700	32	0.4	0.006	0.013	
	10	90	2900	700	40	0.5	0.008	0.015	
	12	90	2400	600	48	0.6	0.008	0.016	
	16	90	1800	500	64	0.8	0.009	0.019	
	20	90	1400	400	80	1.0	0.010	0.019	
N Copper, Copper alloy	6	200	10600	1800	24	0.6	0.008	0.015	
	8	200	8000	1800	32	0.8	0.011	0.020	
	10	200	6400	1600	40	1.0	0.012	0.022	
	12	200	5300	1600	48	1.2	0.014	0.027	
	16	200	4000	1400	64	1.6	0.017	0.032	
	20	200	3200	1300	80	2.0	0.019	0.037	
S Heat resistant alloy	6	30	1600	100	24	0.12	0.002	0.003	
	8	30	1200	100	32	0.16	0.002	0.004	
	10	30	1000	100	40	0.20	0.003	0.005	
	12	30	800	100	48	0.24	0.003	0.005	
	16	30	600	80	64	0.32	0.003	0.006	
	20	30	500	80	80	0.40	0.003	0.007	

1/1

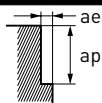

1. SMART MIRACLE coating has very low electrical conductivity; therefore, an electrical contact type of tool setter may not work. When measuring the tool length, please use a mechanical contact type or a laser tool setter.
2. The irregular pitch flute end mill has a larger effect on controlling vibration when compared to standard end mills. However, if the rigidity of the machine or the workpiece material installation is poor, vibration or abnormal sounds can occur. In that case, please adjust the revolution, feed rate and depth of cut.
3. The revolution and feed rate can be increased with a smaller depth of cut.
4. For machining stainless steel, titanium alloys and heat resistant alloys, the use of water-soluble coolant is effective.

VQELCS



END MILL, EXTRA LONG CUT LENGTH, 5 FLUTE, IRREGULAR PITCH FLUTES, CHIPBREAKER

P M N S

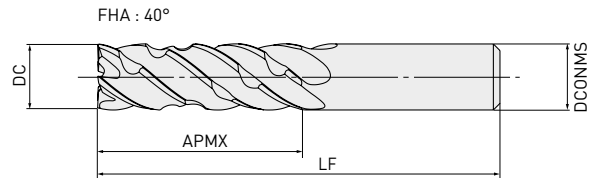

DC ≤ 12	DC > 12
0	0
-0.030	-0.040



DCONMS=6	DCONMS=8, 10	DCONMS=12	DCONMS=16	DCONMS=20
0	0	0	0	0
-0.005	-0.006	-0.008	-0.011	-0.013

- Chipbreaker type end mill for efficient chip breaking capabilities that also provides good surface finishes.
- A high rigidity SMART MIRACLE vibration damping end mill for high efficiency trochoidal milling.

Order number	Stock	DC	APMX	LF	DCONMS	ZEFP
VQELCSD0600	●	6	30	80	6	
VQELCSD0800	●	8	40	100	8	
VQELCSD1000	●	10	50	110	10	
VQELCSD1200	●	12	60	125	12	5
VQELCSD1600	●	16	80	150	16	
VQELCSD2000	●	20	100	170	20	

1/1

1. SMART MIRACLE coating has very low electrical conductivity; therefore, an electrical contact type of tool setter may not work. When measuring the tool length, please use a mechanical contact type or a laser tool setter.



VQELCS

RECOMMENDED CUTTING CONDITIONS

SIDE MILLING

Material	DC	Vc	n	Vf	ap	ae	hm	h max	
P Carbon steel, Alloy steel, Mild steel	6	160	8500	1400	30	0.5	0.007	0.013	
	8	160	6400	1400	40	0.6	0.009	0.018	
	10	160	5100	1300	50	0.8	0.011	0.021	
	12	160	4200	1300	60	0.9	0.013	0.025	
	16	160	3200	1100	80	1.2	0.014	0.028	
	20	160	2500	950	100	1.5	0.016	0.031	
	Pre-hardened steel, Alloy tool steel	6	150	8000	1100	30	0.5	0.006	0.011
		8	150	6000	1200	40	0.6	0.008	0.016
		10	150	4800	1100	50	0.8	0.009	0.018
		12	150	4000	1100	60	0.9	0.011	0.022
16		150	3000	950	80	1.2	0.013	0.026	
M Austenitic, Ferritic and martensitic stainless steel,	6	90	4800	700	30	0.2	0.004	0.009	
	8	90	3600	700	40	0.3	0.006	0.012	
	10	90	2900	600	50	0.4	0.006	0.012	
	12	90	2400	600	60	0.5	0.008	0.015	
	16	90	1800	500	80	0.6	0.008	0.017	
S Titanium alloy	20	90	1400	400	100	0.8	0.009	0.017	
	M Hardened stainless steel, Cobalt chromium alloy	6	80	4200	600	30	0.2	0.004	0.009
		8	80	3200	600	40	0.3	0.006	0.011
10		80	2500	600	50	0.4	0.007	0.014	
12		80	2100	500	60	0.5	0.007	0.014	
16		80	1600	400	80	0.6	0.008	0.015	
N Copper, Copper alloy	20	80	1300	350	100	0.8	0.008	0.016	
	6	180	9500	1600	30	0.5	0.007	0.014	
	8	180	7200	1600	40	0.6	0.009	0.018	
	10	180	5700	1500	50	0.8	0.011	0.021	
	12	180	4800	1500	60	0.9	0.013	0.025	
S Heat resistant alloy	16	180	3600	1300	80	1.2	0.015	0.029	
	20	180	2900	1200	100	1.5	0.017	0.033	
	6	25	1300	90	30	0.10	0.001	0.003	
	8	25	1000	90	40	0.12	0.002	0.003	
	10	25	800	90	50	0.16	0.002	0.004	
	12	25	700	80	60	0.18	0.002	0.004	
16	25	500	70	80	0.24	0.003	0.005		
20	25	400	70	100	0.30	0.003	0.007		

1/1

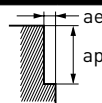

1. SMART MIRACLE coating has very low electrical conductivity; therefore, an electrical contact type of tool setter may not work. When measuring the tool length, please use a mechanical contact type or a laser tool setter.
2. The irregular pitch flute end mill has a larger effect on controlling vibration when compared to standard end mills. However, if the rigidity of the machine or the workpiece material installation is poor, vibration or abnormal sounds can occur. In that case, please adjust the revolution, feed rate and depth of cut.
3. The revolution and feed rate can be increased with a smaller depth of cut.
4. For machining stainless steel, titanium alloys and heat resistant alloys, the use of water-soluble coolant is effective.

VQ6MHVCH



END MILL, MEDIUM CUT LENGTH,
IRREGULAR HELIX FLUTES, 6 FLUTE,
WITH MULTIPLE INTERNAL THROUGH COOLANT HOLES

M

S

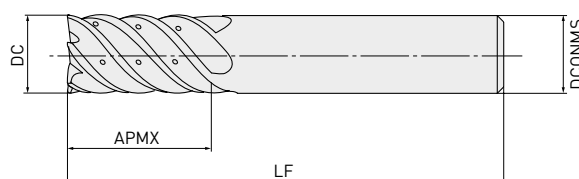

DC ≤ 12	DC > 12
0	0
-0.020	-0.030



DCONMS = 10	DCONMS = 12	DCONMS = 16	DCONMS = 20
0	0	0	0
-0.009	-0.011	-0.011	-0.013

- Multiple coolant channels ensure improved chip removal for reliable machining of difficult-to-cut materials.

Order number	Stock	DC	APMX	LF	DCONMS	ZEFP
VQ6MHVCHD1000	●	10	22	70	10	
VQ6MHVCHD1200	●	12	26	75	12	
VQ6MHVCHD1600	●	16	32	90	16	6
VQ6MHVCHD2000	●	20	38	100	20	

1/1



VQ6MHVCH

RECOMMENDED CUTTING CONDITIONS

Shoulder Milling

Material	DC	n	Vf
M Austenitic stainless steel (<200HB),	10	4800	2000
	12	4000	2000
S Titanium alloy	16	3000	1600
	20	2400	1400
S Heat resistant alloy	10	1300	260
	12	1100	230
	16	800	180
	20	640	150

1/1

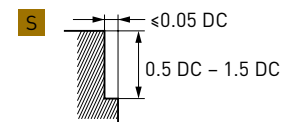
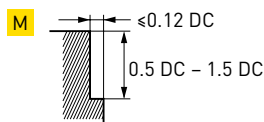

Trochoidal Milling

Material	DC	n	Vf
M Austenitic stainless steel (<200HB),	10	4800	1400
	12	4000	1200
S Titanium alloy	16	3000	1100
	20	2400	900

1/1

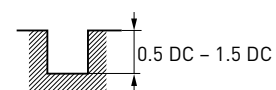
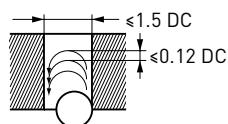

1. If the depth of cut is shallow, the revolution and feed rate can be increased.
2. The irregular helix flute end mill has a larger effect on controlling vibration when compared to standard end mills. However, if the rigidity of the machine or the workpiece installation is very low, then vibration can occur. In this case, please reduce the revolution and feed rate proportionately.

VQXL



END MILL, SHORT CUT LENGTH, LONG NECK, 4 FLUTE

P M N S

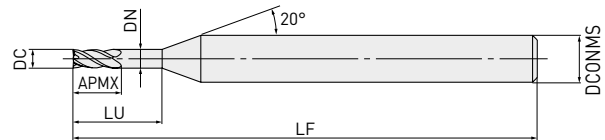

DC < 12

0
-0.010

DCONMS = 4

0
-0.005

- Enhancing efficiency with improved chip disposal by adopting the VQ coating.
- Increased number of flutes provides high efficiency and longer tool life.

Order number	Stock	DC	APMX	LF	LU	DN	DCONMS	ZEFP
VQXLD0020N006	●	0.2	0.3	40	0.6	0.18	4	3
VQXLD0030N009	●	0.3	0.5	40	0.9	0.28	4	3
VQXLD0030N015	●	0.3	0.5	40	1.5	0.28	4	3
VQXLD0040N010	●	0.4	0.6	40	1	0.37	4	4
VQXLD0040N018	●	0.4	0.6	40	1.8	0.37	4	4
VQXLD0050N015	●	0.5	0.7	40	1.5	0.46	4	4
VQXLD0050N025	●	0.5	0.7	40	2.5	0.46	4	4
VQXLD0050N030	●	0.5	0.7	40	3	0.46	4	4
VQXLD0060N030	●	0.6	0.9	40	3	0.57	4	4
VQXLD0070N035	●	0.7	1	40	3.5	0.67	4	4
VQXLD0080N024	●	0.8	1.2	40	2.4	0.77	4	4
VQXLD0080N030	●	0.8	1.2	40	3	0.77	4	4
VQXLD0080N040	●	0.8	1.2	40	4	0.77	4	4
VQXLD0100N050	●	1	1.5	40	5	0.96	4	4

1/1



VQXL

RECOMMENDED CUTTING CONDITIONS

SHOULDER MILLING

Material	DC	LU	n	Vf	ap	ae	
P	0.2	0.6	40000	360	0.03	0.01	
	0.3	0.9	40000	480	0.04	0.01	
	0.3	1.5	40000	360	0.04	0.01	
M Carbon steel, Alloy steel, Mild steel,	0.4	1.2	40000	800	0.06	0.02	
	0.4	2	40000	560	0.06	0.02	
	0.5	1.5	38000	910	0.07	0.02	
N Alloy tool steel, Austenitic stainless steel, Titanium alloy, Cobalt chromium alloy,	0.5	2.5	38000	610	0.07	0.02	
	0.5	3	38000	550	0.07	0.02	
	0.6	3	32000	640	0.09	0.03	
S Copper, Copper alloy	0.7	3.5	27000	650	0.11	0.03	
	0.8	2.4	24000	960	0.12	0.04	
	0.8	3	24000	860	0.12	0.04	
	0.8	4	24000	670	0.12	0.04	
	1	5	20000	800	0.15	0.05	
	S Heat resistant alloy, Pre-hardened steel, Hardened steel	0.2	0.6	32000	290	0.03	0.01
		0.3	0.9	21000	250	0.04	0.01
0.3		1.5	21000	190	0.04	0.01	
0.4		1.2	16000	320	0.06	0.02	
0.4		2	16000	220	0.06	0.02	
0.5		1.5	13000	310	0.07	0.02	
0.5		2.5	13000	210	0.07	0.02	
0.5		3	13000	180	0.07	0.02	
0.6		3	10500	210	0.09	0.03	
0.7		3.5	9100	200	0.11	0.03	
0.8		2.4	8000	260	0.12	0.04	
0.8		3	8000	230	0.12	0.04	
0.8		4	8000	190	0.12	0.04	
1	5	6500	210	0.15	0.05		

1/1

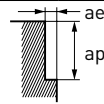

VQXL

FACE MILLING

Material	DC	LU	n	Vf	ap	ae
P	0.2	0.6	40000	360	0.01	<0.2
	0.3	0.9	40000	480	0.02	<0.3
	0.3	1.5	40000	360	0.02	<0.3
M	0.4	1.2	40000	800	0.03	<0.4
	0.4	2	40000	560	0.02	<0.4
N	0.5	1.5	38000	910	0.04	<0.5
	0.5	2.5	38000	610	0.03	<0.5
S	0.5	3	38000	550	0.03	<0.5
	0.6	3	32000	640	0.03	<0.6
S	0.7	3.5	27000	640	0.03	<0.7
	0.8	2.4	24000	960	0.06	<0.8
	0.8	3	24000	840	0.05	<0.8
	0.8	4	24000	670	0.04	<0.8
	1	5	20000	800	0.05	<1
	0.2	0.6	32000	290	0.015	<0.1
	0.3	0.9	21000	250	0.025	<0.1
	0.3	1.5	21000	190	0.02	<0.1
	0.4	1.2	16000	320	0.03	<0.2
	0.4	2	16000	220	0.02	<0.2
S	0.5	1.5	13000	310	0.04	<0.2
	0.5	2.5	13000	210	0.03	<0.2
	0.5	3	13000	180	0.03	<0.2
	0.6	3	10500	210	0.035	<0.3
	0.7	3.5	9100	190	0.035	<0.3
	0.8	2.4	8000	260	0.06	<0.4
	0.8	3	8000	230	0.05	<0.4
	0.8	4	8000	190	0.04	<0.4
	1	5	6500	210	0.05	<0.5

1/1

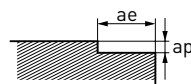

1. SMART MIRACLE coating has very low electrical conductivity; therefore, an electrical contact type of tool setter may not work. When measuring the tool length, please use a mechanical contact type or a laser tool setter.
2. Effective machining of stainless steel, titanium alloys and heat-resistant alloys etc. can be achieved with the use of emulsion coolant.
3. Chattering can still occur if the machine rigidity and clamping method are insufficient. In these cases the feed and speed should be reduced proportionately.

VQXL

SLOTTING

Material	DC	LU	n	Vf	ap
P	0.2	0.6	30000	270	0.03
	0.3	0.9	30000	360	0.04
M	0.3	1.5	30000	270	0.04
	0.4	1.2	30000	600	0.06
	0.4	2	30000	420	0.06
N	0.5	1.5	28000	670	0.07
	0.5	2.5	28000	450	0.07
S	0.5	3	28000	390	0.07
	0.6	3	24000	480	0.09
S	0.7	3.5	20000	480	0.1
	0.8	2.4	18000	720	0.1
	0.8	3	18000	650	0.1
	0.8	4	18000	500	0.1
	1	5	15000	600	0.1
	0.2	0.6	24000	220	0.03
	0.3	0.9	15000	180	0.04
	0.3	1.5	15000	140	0.04
	0.4	1.2	12000	240	0.06
	0.4	2	12000	170	0.06
S	0.5	1.5	9500	230	0.07
	0.5	2.5	9500	150	0.07
	0.5	3	9500	130	0.07
	0.6	3	7800	160	0.09
	0.7	3.5	6800	140	0.1
	0.8	2.4	6000	190	0.1
	0.8	3	6000	170	0.1
	0.8	4	6000	140	0.1
	1	5	4800	150	0.1

1/1

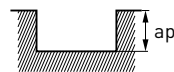

1. SMART MIRACLE coating has very low electrical conductivity; therefore, an electrical contact type of tool setter may not work. When measuring the tool length, please use a mechanical contact type or a laser tool setter.
2. Effective machining of stainless steel, titanium alloys and heat-resistant alloys etc. can be achieved with the use of emulsion coolant.
3. Chattering can still occur if the machine rigidity and clamping method are insufficient. In these cases the feed and speed should be reduced proportionately.

VQMHSV

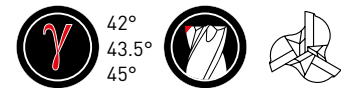

END MILL, MEDIUM CUT LENGTH, 3 FLUTE, FOR PLUNGING AND SLOTTING



DC < 12	DC > 12
0	0
-0.02	-0.03



4 < D4 < 6	8 < D4 < 10	12 < D4 < 16	D4 = 20
0	0	0	0
-0.008	-0.009	-0.011	-0.013

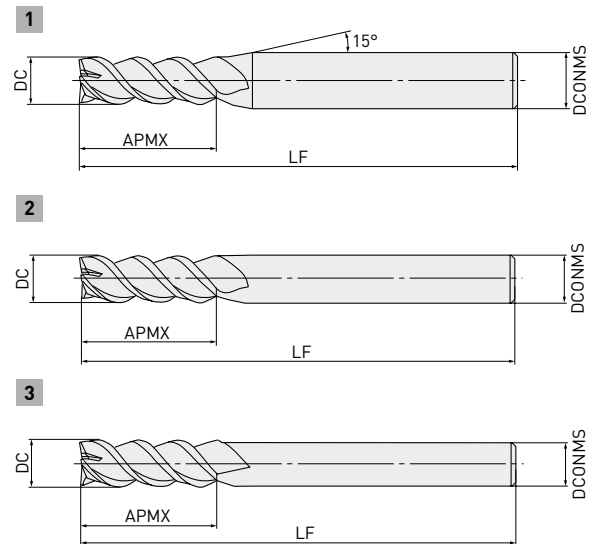

- 3 flute end mill for both plunging and slotting.
- Featuring irregular helical geometry for reduced chattering.

Order number	Stock	DC	APMX	LF	DCONMS	ZEFP	Type
VQMHSV0100	●	1	2	45	4	3	1
VQMHSV0110	●	1.1	2.2	45	4	3	1
VQMHSV0120	●	1.2	2.4	45	4	3	1
VQMHSV0130	●	1.3	2.6	45	4	3	1
VQMHSV0140	●	1.4	2.8	45	4	3	1
VQMHSV0150	●	1.5	3	45	4	3	1
VQMHSV0160	●	1.6	3.2	45	4	3	1
VQMHSV0170	●	1.7	3.4	45	4	3	1
VQMHSV0180	●	1.8	3.6	45	4	3	1
VQMHSV0190	●	1.9	3.8	45	4	3	1
VQMHSV0200	●	2	4	50	6	3	1
VQMHSV0210	●	2.1	4.2	50	6	3	1
VQMHSV0220	●	2.2	4.4	50	6	3	1
VQMHSV0230	●	2.3	4.6	50	6	3	1
VQMHSV0240	●	2.4	4.8	50	6	3	1
VQMHSV0250	●	2.5	5	50	6	3	1
VQMHSV0260	●	2.6	5.2	50	6	3	1
VQMHSV0270	●	2.7	5.4	50	6	3	1
VQMHSV0280	●	2.8	5.6	50	6	3	1
VQMHSV0290	●	2.9	5.8	50	6	3	1
VQMHSV0300	●	3	6	50	6	3	1

1/2

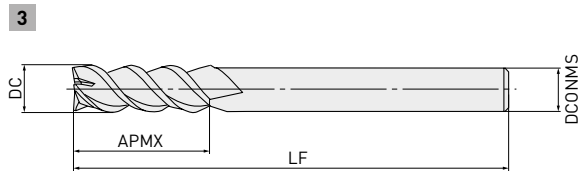
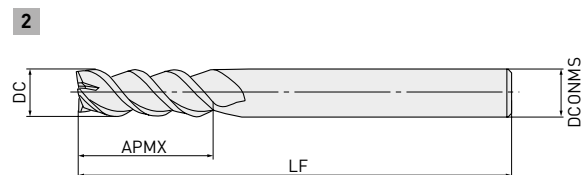
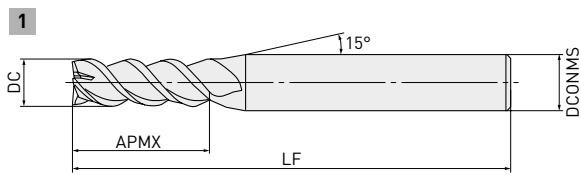

VQMHZV - END MILL, MEDIUM CUT LENGTH, 3 FLUTE, FOR PLUNGING AND SLOTTING

Order number	Stock	DC	APMX	LF	DCONMS	ZEFP	Type
VQMHZVD0310	●	3.1	7	50	6	3	1
VQMHZVD0320	●	3.2	7	50	6	3	1
VQMHZVD0330	●	3.3	7	50	6	3	1
VQMHZVD0340	●	3.4	7	50	6	3	1
VQMHZVD0350	●	3.5	8	50	6	3	1
VQMHZVD0360	●	3.6	8	50	6	3	1
VQMHZVD0370	●	3.7	8	50	6	3	1
VQMHZVD0380	●	3.8	8	50	6	3	1
VQMHZVD0390	●	3.9	8	50	6	3	1
VQMHZVD0400	●	4	8	50	6	3	1
VQMHZVD0450	●	4.5	10	50	6	3	1
VQMHZVD0500	●	5	10	50	6	3	1
VQMHZVD0550	●	5.5	13	50	6	3	1
VQMHZVD0600	●	6	13	60	6	3	2
VQMHZVD0650	●	6.5	16	60	8	3	1
VQMHZVD0700	●	7	16	60	8	3	1
VQMHZVD0750	●	7.5	16	60	8	3	1
VQMHZVD0800	●	8	19	70	8	3	2
VQMHZVD0850	●	8.5	19	70	10	3	1
VQMHZVD0900	●	9	19	70	10	3	1
VQMHZVD0950	●	9.5	19	70	10	3	1
VQMHZVD1000	●	10	22	80	10	3	2
VQMHZVD1100	●	11	22	80	12	3	1
VQMHZVD1200	●	12	26	90	12	3	2
VQMHZVD1300	●	13	26	90	12	3	3
VQMHZVD1400	●	14	26	90	12	3	3
VQMHZVD1500	●	15	26	110	16	3	1
VQMHZVD1600	●	16	30	110	16	3	2
VQMHZVD2000	●	20	32	140	20	3	2

2/2



VQMHSV

RECOMMENDED CUTTING CONDITIONS

SHOULDER MILLING

HIGH EFFICIENCY CUTTING CONDITIONS

Material	DC	n	Vf	ap	ae
Carbon steel, Alloy steel, Mild steel	1	32000	720	1.5	0.2
	1.5	28000	1300	2.2	0.3
	2	24000	1800	3	0.6
	3	16000	1900	4.5	0.9
	4	12000	2000	6	1.2
	5	9500	1900	7.5	1.5
	6	8000	1900	9	1.8
	8	6000	1900	12	2.4
	10	4800	1700	15	3
	12	4000	1400	18	3.6
	16	3000	1200	24	4.8
	20	2400	970	30	6
	Pre-hardened steel, Carbon steel, Alloy steel, Alloy tool steel	1	25000	530	1.5
1.5		21000	630	2.2	0.3
2		19000	860	3	0.6
3		13000	940	4.5	0.9
4		9500	940	6	1.2
5		7600	960	7.5	1.5
6		6400	960	9	1.8
8		4800	1000	12	2.4
10		3800	910	15	3
12		3200	860	18	3.6
16		2400	720	24	4.8
20		1900	570	30	6
Austenitic, Ferritic and martensitic stainless steel, Titanium alloy		1	19000	430	1.5
	1.5	18000	540	2.2	0.3
	2	16000	620	3	0.6
	3	11000	660	4.5	0.9
	4	8000	670	6	1.2
	5	6400	670	7.5	1.5
	6	5300	830	9	1.8
	8	4000	900	12	2.4
	10	3200	960	15	3
	12	2700	890	18	3.6
	16	2000	720	24	4.8
	20	1600	580	30	6
	Hardened stainless steel, Cobalt chromium alloy	1	16000	340	1.5
1.5		14000	420	2.2	0.1
2		12000	540	3	0.4
3		8000	580	4.5	0.6
4		6000	590	6	0.8
5		4800	600	7.5	1
6		4000	600	9	1.2
8		3000	630	12	1.6
10		2400	580	15	2
12		2000	540	18	2.4
16		1500	450	24	3.2
20		1200	360	30	4

1/1



VQMHZV

GENERAL PURPOSE CUTTING CONDITIONS

Material	DC	n	Vf	ap	ae
Carbon steel, Alloy steel, Mild steel	1	32000	480	1.5	0.2
	1.5	25000	740	2.2	0.3
	2	19000	940	3	0.6
	3	13000	1000	4.5	0.9
	4	9500	1000	6	1.2
	5	7600	980	7.5	1.5
	6	6400	1000	9	1.8
	8	4800	1000	12	2.4
	10	3800	900	15	3
	12	3200	760	18	3.6
	16	2400	640	24	4.8
	20	1900	510	30	6
Pre-hardened steel, Carbon steel, Alloy steel, Alloy tool steel	1	25000	350	1.5	0.2
	1.5	21000	420	2.2	0.3
	2	16000	480	3	0.6
	3	11000	520	4.5	0.9
	4	8000	520	6	1.2
	5	6400	530	7.5	1.5
	6	5300	520	9	1.8
	8	4000	550	12	2.4
	10	3200	510	15	3
	12	2700	480	18	3.6
	16	2000	400	24	4.8
	20	1600	320	30	6
Austenitic, Ferritic and martensitic stainless steel, Titanium alloy	1	19000	280	1.5	0.2
	1.5	17000	340	2.2	0.3
	2	13000	330	3	0.6
	3	8500	340	4.5	0.9
	4	6400	350	6	1.2
	5	5100	350	7.5	1.5
	6	4200	290	9	1.8
	8	3200	310	12	2.4
	10	2500	500	15	3
	12	2100	460	18	3.6
	16	1600	250	24	4.8
	20	1300	200	30	6

1/2

VQMHZV – GENERAL PURPOSE CUTTING CONDITIONS

Material	DC	n	Vf	ap	ae
M Hardened stainless steel, Cobalt chromium alloy	1	16000	220	1.5	0.1
	1.5	14000	280	2.2	0.1
	2	11000	330	3	0.4
	3	7400	350	4.5	0.6
	4	5600	370	6	0.8
	5	4500	370	7.5	1
	6	3700	370	9	1.2
	8	2800	390	12	1.6
	10	2200	350	15	2
	12	1900	340	18	2.4
	16	1400	280	24	3.2
	20	1100	220	30	4

2/2



1. SMART MIRACLE coating has very low electrical conductivity; therefore, an electrical contact type of tool setter may not work. When measuring the tool length, please use a mechanical contact type or a laser tool setter.
2. Effective machining of stainless steel, titanium alloys and heat-resistant alloys etc. can be achieved with the use of emulsion coolant.
3. Chattering can still occur if the machine rigidity and clamping method are insufficient. In these cases the feed and speed should be reduced proportionately.
4. When the depth of cut is smaller than shown the revolution and feed rate can be increased.

VQMHZV

SHOULDER MILLING

HIGH EFFICIENCY CUTTING CONDITIONS

Material	DC	n	Vf	ap	ae
N Copper, Copper alloy	1	38000	860	1.5	0.2
	1.5	32000	1400	2.2	0.3
	2	29000	2200	3	0.6
	3	19000	2300	4.5	0.9
	4	14000	2300	6	1.2
	5	11000	2100	7.5	1.5
	6	9500	2300	9	1.8
	8	7200	2300	12	2.4
	10	5700	2100	15	3
	12	4800	1700	18	3.6
	16	3600	1500	24	4.8
	20	2900	1200	30	6
S Heat resistant alloy	1	13000	160	1.5	0.05
	1.5	8500	170	2.2	0.08
	2	6400	170	3	0.2
	3	4200	180	4.5	0.3
	4	3200	180	6	0.4
	5	2500	180	7.5	0.5
	6	2100	190	9	0.6
	8	1600	190	12	0.8
	10	1300	220	15	1
	12	1100	210	18	1.2
	16	800	150	24	1.6
	20	640	120	30	2

1/1



VQMHZV

GENERAL PURPOSE CUTTING CONDITIONS

Material	DC	n	Vf	ap	ae
N Copper, Copper alloy	1	38000	560	1.5	0.2
	1.5	30000	890	2.2	0.3
	2	22000	1100	3	0.6
	3	15000	1200	4.5	0.9
	4	11000	1200	6	1.2
	5	8900	1100	7.5	1.5
	6	7400	1200	9	1.8
	8	5600	1200	12	2.4
	10	4500	1100	15	3
	12	3700	880	18	3.6
	16	2800	750	24	4.8
	20	2200	590	30	6
S Heat resistant alloy	1	9500	75	1.5	0.05
	1.5	6400	82	2.2	0.07
	2	4800	86	3	0.2
	3	3200	89	4.5	0.3
	4	2400	90	6	0.4
	5	1900	90	7.5	0.5
	6	1600	95	9	0.6
	8	1200	95	12	0.8
	10	950	110	15	1
	12	800	100	18	1.2
	16	600	76	24	1.6
	20	480	61	30	2

1/1



1. SMART MIRACLE coating has very low electrical conductivity; therefore, an electrical contact type of tool setter may not work.
When measuring the tool length, please use a mechanical contact type or a laser tool setter.
2. Effective machining of stainless steel, titanium alloys and heat-resistant alloys etc. can be achieved with the use of emulsion.
3. Chattering can still occur if the machine rigidity and clamping method are insufficient.
In these cases the feed and speed should be reduced proportionately.
4. When the depth of cut is smaller than shown the revolution and feed rate can be increased.

VQMHZV

SLOTTING

HIGH EFFICIENCY CUTTING CONDITIONS

Material	DC	n	Vf	ap
P Carbon steel, Alloy steel, Mild steel	1	32000	380	0.5
	1.5	28000	590	0.7
	2	24000	940	2
	3	16000	1100	3
	4	12000	1400	4
	5	9500	1400	5
	6	8000	1400	6
	8	6000	1300	8
	10	4800	1200	10
	12	4000	960	12
	16	3000	810	12
	20	2400	650	12
	P Pre-hardened steel, Carbon steel, Alloy steel, Alloy tool steel	1	25000	150
1.5		21000	250	0.7
2		19000	460	2
3		13000	550	3
4		9500	680	4
5		7600	680	5
6		6400	770	6
8		4800	720	8
10		3800	630	10
12		3200	580	12
16		2400	500	12
20		1900	400	12
M Austenitic, Ferritic and martensitic stainless steel, Titanium alloy		1	19000	100
	1.5	18000	220	0.7
	2	16000	480	2
	3	11000	500	3
	4	8000	530	4
	5	6400	540	5
	6	5300	560	6
	8	4000	600	8
	10	3200	670	10
	12	2700	650	12
	16	2000	480	12
	20	1600	380	12
	S Hardened stainless steel, Cobalt chromium alloy	1	14000	80
1.5		12000	140	0.4
2		9500	230	1
3		6400	270	1.5
4		4800	350	2
5		3800	340	2.5
6		3200	380	3
8		2400	360	4
10		1900	310	5
12		1600	290	6
16		1200	250	8
20		950	200	10

VQMHZV – SLOTTING – HIGH EFFICIENCY CUTTING CONDITIONS

Material	DC	n	Vf	ap
N Copper, Copper alloy	1	38000	460	0.5
	1.5	32000	670	0.7
	2	29000	1100	2
	3	19000	1300	3
	4	14000	1700	4
	5	11000	1700	5
	6	9500	1700	6
	8	7200	1500	8
	10	5700	1400	10
	12	4800	1200	12
	16	3600	970	12
	20	2900	780	12
S Heat resistant alloy	1	9500	60	0.2
	1.5	6400	80	0.3
	2	4800	100	0.6
	3	3200	120	0.9
	4	2400	130	1.2
	5	1900	130	1.5
	6	1600	130	1.8
	8	1200	140	2.4
	10	950	160	3
	12	800	150	3.6
	16	600	120	4.8
	20	480	90	6

2/2

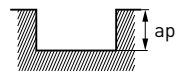

VQMHZV

GENERAL PURPOSE CUTTING CONDITIONS

Material	DC	n	Vf	ap
P Carbon steel, Alloy steel, Mild steel	1	32000	250	0.5
	1.5	21000	290	0.7
	2	16000	410	2
	3	11000	500	3
	4	8000	630	4
	5	6400	630	5
	6	5300	630	6
	8	4000	550	8
	10	3200	510	10
	12	2700	430	12
	16	2000	360	12
	20	1600	290	12
	M Pre-hardened steel, Carbon steel, Alloy steel, Alloy tool steel	1	25000	99
1.5		17000	130	0.7
2		13000	210	2
3		8500	240	3
4		6400	300	4
5		5100	300	5
6		4200	330	6
8		3200	320	8
10		2500	270	10
12		2100	250	12
16		1600	220	12
20		1300	180	12
S Austenitic, Ferritic and martensitic stainless steel, Titanium alloy		1	19000	80
	1.5	13000	100	0.7
	2	9500	190	2
	3	6400	190	3
	4	4800	210	4
	5	3800	210	5
	6	3200	220	6
	8	2400	240	8
	10	1900	260	10
	12	1600	250	12
	16	1200	190	12
	20	950	150	12
	M Hardened stainless steel, Cobalt chromium alloy	1	14000	60
1.5		11000	87	0.4
2		8000	130	1
3		5300	150	1.5
4		4000	190	2
5		3200	190	2.5
6		2700	210	3
8		2000	200	4
10		1600	170	5
12		1300	150	6
16		990	140	8
20		800	110	10

VQMHZV – GENERAL PURPOSE CUTTING CONDITIONS

Material	DC	n	Vf	ap
N Copper, Copper alloy	1	38000	300	0.5
	1.5	25000	350	0.7
	2	19000	490	2
	3	13000	590	3
	4	9500	750	4
	5	7600	750	5
	6	6400	760	6
	8	4800	670	8
	10	3800	600	10
	12	3200	510	12
	16	2400	430	12
20	1900	340	12	
S Heat resistant alloy	1	8000	30	0.2
	1.5	5300	40	0.3
	2	4000	55	0.6
	3	2700	64	0.9
	4	2000	70	1.2
	5	1600	71	1.5
	6	1300	72	1.8
	8	990	78	2.4
	10	800	89	3
	12	660	84	3.6
	16	500	63	4.8
20	400	50	6	

2/2

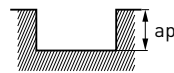

1. SMART MIRACLE coating has very low electrical conductivity; therefore, an electrical contact type of tool setter may not work. When measuring the tool length, please use a mechanical contact type or a laser tool setter.
2. Effective machining of stainless steel, titanium alloys and heat-resistant alloys etc. can be achieved with the use of emulsion coolant.
3. Chattering can still occur if the machine rigidity and clamping method are insufficient. In these cases the feed and speed should be reduced proportionately.
4. When the depth of cut is smaller than shown the revolution and feed rate can be increased.

VQMHZV

PLUNGING

HIGH EFFICIENCY CUTTING CONDITIONS

Material	DC	n	Vf	ap	p
Carbon steel, Alloy steel, Mild steel	1	20000	160	0.5	0.1
	1.5	18000	270	0.7	0.3
	2	16000	480	2	0.5
	3	11000	660	3	1
	4	8000	800	4	2
	5	6400	960	5	2.5
	6	5300	950	6	3
	8	4000	720	8	4
	10	3200	580	10	5
	12	2700	490	12	5
	16	2000	360	16	5
	20	1600	290	20	5
	Pre-hardened steel, Carbon steel, Alloy steel, Alloy tool steel	1	16000	100	0.5
1.5		13000	120	0.7	0.3
2		11000	200	2	0.4
3		7400	270	3	0.6
4		5600	340	4	0.8
5		4500	410	5	1
6		3700	440	6	1.2
8		2800	340	8	1.6
10		2200	260	10	2.5
12		1900	230	12	3
16		1400	170	16	4
20		1100	130	20	5
Austenitic, Ferritic and martensitic stainless steel, Titanium alloy		1	16000	50	0.5
	1.5	13000	80	0.7	0.1
	2	9500	90	1	0.1
	3	6400	100	1.5	0.2
	4	4800	100	2	0.4
	5	3800	100	2.5	0.5
	6	3200	100	3	0.6
	8	2400	70	4	0.6
	10	1900	60	5	0.6
	12	1600	50	6	0.6
Hardened stainless steel, Cobalt chromium alloy	1	9500	30	0.5	0.05
	1.5	7400	40	0.7	0.1
	2	6400	60	1	0.1
	3	4200	60	1.5	0.2
	4	3200	60	2	0.4
	5	2500	60	2.5	0.5
	6	2100	60	3	0.6
	8	1600	50	4	0.6
	10	1300	40	5	0.6
	12	1100	30	6	0.6
16	800	20	8	0.6	
20	640	20	10	0.6	

VQMHZV – PLUNGING – HIGH EFFICIENCY CUTTING CONDITIONS

Material	DC	n	Vf	ap	p
N Copper, Copper alloy	1	24000	190	0.5	0.1
	1.5	21000	320	0.7	0.3
	2	19000	570	2	0.5
	3	13000	780	3	0.9
	4	9500	950	4	2
	5	7600	1100	5	2.5
	6	6400	1200	6	3
	8	4800	860	8	4
	10	3800	680	10	5
	12	3200	580	12	5
	16	2400	430	16	5
	20	1900	340	20	5

2/2

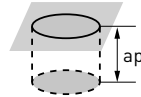

VQMHZV

GENERAL PURPOSE CUTTING CONDITIONS

Material	DC	n	Vf	ap	p	
P Carbon steel, Alloy steel, Mild steel	1	20000	160	0.5	0.05	
	1.5	18000	270	0.7	0.1	
	2	16000	480	2	0.2	
	3	11000	660	3	0.3	
	4	8000	800	4	0.4	
	5	6400	960	5	0.5	
	6	5300	950	6	0.6	
	8	4000	720	8	0.7	
	10	3200	580	10	0.7	
	12	2700	490	12	0.7	
	16	2000	360	16	0.7	
	20	1600	290	20	0.7	
	M Pre-hardened steel, Carbon steel, Alloy steel, Alloy tool steel	1	16000	100	0.5	0.05
		1.5	13000	120	0.7	0.1
2		11000	200	2	0.2	
3		7400	270	3	0.3	
4		5600	340	4	0.4	
5		4500	410	5	0.5	
6		3700	440	6	0.6	
8		2800	340	8	0.7	
10		2200	260	10	0.7	
12		1900	230	12	0.7	
16		1400	170	16	0.7	
20		1100	130	20	0.7	
M S Austenitic, Ferritic and martensitic stainless steel, Titanium alloy		1	16000	50	0.5	0.05
		1.5	13000	80	0.7	0.05
	2	9500	90	1	0.05	
	3	6400	100	1.5	0.1	
	4	4800	100	2	0.2	
	5	3800	100	2.5	0.2	
	6	3200	100	3	0.3	
	8	2400	70	4	0.3	
	10	1900	60	5	0.3	
	12	1600	50	6	0.3	
	16	1200	40	8	0.3	
	20	950	30	10	0.3	
	M Hardened stainless steel, Cobalt chromium alloy	1	9500	30	0.5	0.05
		1.5	7400	40	0.7	0.05
2		6400	60	1	0.05	
3		4200	60	1.5	0.1	
4		3200	60	2	0.2	
5		2500	60	2.5	0.2	
6		2100	60	3	0.3	
8		1600	50	4	0.3	
10		1300	40	5	0.3	
12		1100	30	6	0.3	
16		800	20	8	0.3	
20		640	20	10	0.3	

VQMHZV – GENERAL PURPOSE CUTTING CONDITIONS

Material	DC	n	Vf	ap	p
N Copper, Copper alloy	1	24000	190	0.5	0.05
	1.5	21000	320	0.7	0.1
	2	19000	570	2	0.2
	3	13000	780	3	0.3
	4	9500	950	4	0.4
	5	7600	1100	5	0.5
	6	6400	1200	6	0.6
	8	4800	860	8	0.7
	10	3800	680	10	0.7
	12	3200	580	12	0.7
	16	2400	430	16	0.7
	20	1900	340	20	0.7

2/2

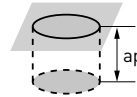

1. SMART MIRACLE coating has very low electrical conductivity; therefore, an electrical contact type of tool setter may not work. When measuring the tool length, please use a mechanical contact type or a laser tool setter.
2. Effective machining of stainless steel, titanium alloys and heat-resistant alloys etc. can be achieved with the use of emulsion coolant.
3. Chattering can still occur if the machine rigidity and clamping method are insufficient. In these cases the feed and speed should be reduced proportionately.

VQMZHVOH

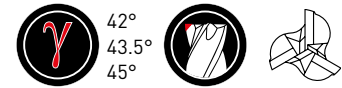

END MILL, MEDIUM CUT LENGTH, 3 FLUTE,
FOR PLUNGING AND SLOTTING, WITH MULTIPLE
INTERNAL THROUGH COOLANT HOLES

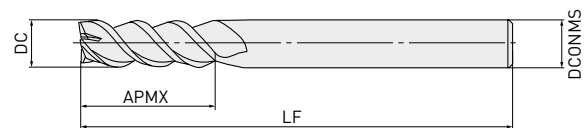

DC < 12	DC = 16
0	0
-0.02	-0.03



D4 = 6	8 < D4 < 10	12 < D4 < 16
0	0	0
-0.008	-0.009	-0.011

- 3 flute end mill for both plunging and slotting.
- Through coolant holes are ideal for high performance plunging and pocketing.

Order number	Stock	DC	APMX	LF	DCONMS	ZEFP
VQMZHVOHD0600	●	6	13	60	6	3
VQMZHVOHD0800	●	8	19	70	8	3
VQMZHVOHD1000	●	10	22	80	10	3
VQMZHVOHD1200	●	12	26	90	12	3
VQMZHVOHD1600	●	16	30	110	16	3

1/1



VQM HZVOH

RECOMMENDED CUTTING CONDITIONS

SLOTTING

HIGH EFFICIENCY CUTTING CONDITIONS

Material	DC	n	Vf	ap
P Carbon steel, Alloy steel, Mild steel	6	8000	1400	6
	8	6000	1300	8
	10	4800	1200	10
	12	4000	960	12
	16	3000	810	12
P Pre-hardened steel, Carbon steel, Alloy steel, Alloy tool steel	6	6400	770	6
	8	4800	720	8
	10	3800	630	10
	12	3200	580	12
	16	2400	500	12
M Austenitic, Ferritic and martensitic stainless steel, Titanium alloy	6	5300	560	6
	8	4000	600	8
	10	3200	670	10
	12	2700	650	12
S Hardened stainless steel, Cobalt chromium alloy	6	3200	380	3
	8	2400	360	4
	10	1900	310	5
	12	1600	290	6
	16	1200	250	8
N Copper, Copper alloy	6	9500	1700	6
	8	7200	1500	8
	10	5700	1400	10
	12	4800	1200	12
	16	3600	970	12
S Heat resistant alloy	6	1600	130	1.8
	8	1200	140	2.4
	10	950	160	3
	12	800	150	3.6
	16	600	120	4.8

1/1

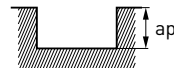

VQMHZVOH

GENERAL PURPOSE CUTTING CONDITIONS

Material	DC	n	Vf	ap
P Carbon steel, Alloy steel, Mild steel	6	5300	630	6
	8	4000	550	8
	10	3200	510	10
	12	2700	430	12
	16	2000	360	12
Pre-hardened steel, Carbon steel, Alloy steel, Alloy tool steel	6	4200	330	6
	8	3200	320	8
	10	2500	270	10
	12	2100	250	12
	16	1600	220	12
M Austenitic, Ferritic and martensitic stainless steel, Titanium alloy	6	3200	220	6
	8	2400	240	8
	10	1900	260	10
	12	1600	250	12
S Hardened stainless steel, Cobalt chromium alloy	6	2700	210	3
	8	2000	200	4
	10	1600	170	5
	12	1300	150	6
	16	990	140	8
N Copper, Copper alloy	6	6400	760	6
	8	4800	670	8
	10	3800	600	10
	12	3200	510	12
	16	2400	430	12
S Heat resistant alloy	6	1300	72	1.8
	8	990	78	2.4
	10	800	89	3
	12	660	84	3.6
	16	500	63	4.8

1/1



1. SMART MIRACLE coating has very low electrical conductivity; therefore, an electrical contact type of tool setter may not work. When measuring the tool length, please use a mechanical contact type or a laser tool setter.
2. Effective machining of stainless steel, titanium alloys and heat-resistant alloys etc. can be achieved with the use of emulsion coolant.
3. Chattering can still occur if the machine rigidity and clamping method are insufficient. In these cases the feed and speed should be reduced proportionately.
4. When the depth of cut is smaller than shown the revolution and feed rate can be increased.

VQMHZVOH**PLUNGING****HIGH EFFICIENCY CUTTING CONDITIONS**

Material	DC	n	Vf	ap	p	
P Carbon steel, Alloy steel, Mild steel	6	5300	950	9	3	
	8	4000	720	12	4	
	10	3200	580	15	5	
	12	2700	490	18	5	
	16	2000	360	24	5	
	Pre-hardened steel, Carbon steel, Alloy steel, Alloy tool steel	6	3700	440	9	1.2
		8	2800	340	12	1.6
		10	2200	260	15	2.5
		12	1900	230	18	3
		16	1400	170	24	4
M Austenitic, Ferritic and martensitic stainless steel, Titanium alloy	6	3200	100	6	0.6	
	8	2400	70	8	0.6	
	10	1900	60	10	0.6	
	12	1600	50	12	0.6	
S Hardened stainless steel, Cobalt chromium alloy	16	1200	40	16	0.6	
	6	2100	60	6	0.6	
	8	1600	50	8	0.6	
	10	1300	40	10	0.6	
	12	1100	30	12	0.6	
M Hardened stainless steel, Cobalt chromium alloy	16	800	20	16	0.6	
	N Copper, Copper alloy	6	6400	1200	9	3
		8	4800	860	12	4
		10	3800	680	15	5
12		3200	580	18	5	
16		2400	430	24	5	

1/1

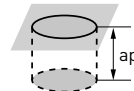

VQMZHVOH

GENERAL PURPOSE CUTTING CONDITIONS

Material	DC	n	Vf	ap	p
P Carbon steel, Alloy steel, Mild steel	6	5300	950	9	0.6
	8	4000	720	12	0.7
	10	3200	580	15	0.75
	12	2700	490	18	0.75
	16	2000	360	24	0.75
Pre-hardened steel, Carbon steel, Alloy steel, Alloy tool steel	6	3700	440	9	0.6
	8	2800	340	12	0.7
	10	2200	260	15	0.75
	12	1900	230	18	0.75
	16	1400	170	24	0.75
M Austenitic, Ferritic and martensitic stainless steel,	6	3200	100	6	0.3
	8	2400	70	8	0.3
	10	1900	60	10	0.3
S Titanium alloy	12	1600	50	12	0.3
	16	1200	40	16	0.3
M Hardened stainless steel, Cobalt chromium alloy	6	2100	60	6	0.3
	8	1600	50	8	0.3
	10	1300	40	10	0.3
	12	1100	30	12	0.3
	16	800	20	16	0.3
N Copper, Copper alloy	6	6400	1200	9	0.6
	8	4800	860	12	0.7
	10	3800	680	15	0.75
	12	3200	580	18	0.75
	16	2400	430	24	0.75

1/1

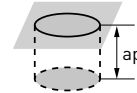

1. SMART MIRACLE coating has very low electrical conductivity; therefore, an electrical contact type of tool setter may not work. When measuring the tool length, please use a mechanical contact type or a laser tool setter.
2. Effective machining of stainless steel, titanium alloys and heat-resistant alloys etc. can be achieved with the use of emulsion coolant.
3. Chattering can still occur if the machine rigidity and clamping method are insufficient. In these cases the feed and speed should be reduced proportionately.

VQ4MVM



END MILL, MEDIUM CUT LENGTH, 4 FLUTE, FOR MULTIFUNCTIONAL MACHINING

P M S

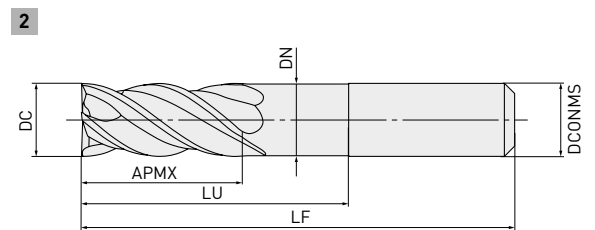
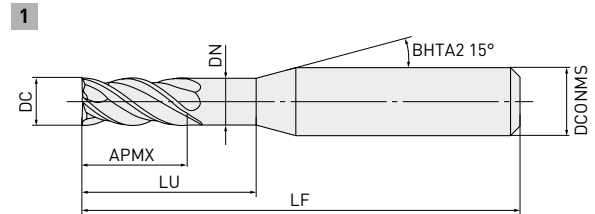

DC ≤ 12

0
-0.020



DCONMS = 6

0
-0.008



DCONMS 8, 10 DCONMS = 12

0 0
-0.009 -0.011

- Multifunctional end mill that enables a strong ramping capability.
- Chip evacuation is improved by increasing the capacity of the radial cutting edge pocket.

Order number	Stock	DC	APMX	LF	DCONMS	LU	DN	ZEFP	Type
VQ4MVMD0400N180	●	4	11	50	6	18	3.85	4	1
VQ4MVMD0500N180	●	5	13	50	6	18	4.85	4	1
VQ4MVMD0600N200	●	6	13	60	6	20	5.85	4	2
VQ4MVMD0800N240	●	8	19	60	8	24	7.85	4	2
VQ4MVMD1000N300	●	10	22	70	10	30	9.70	4	2
VQ4MVMD1200N360	●	12	26	75	12	36	11.70	4	2

1/1

VQ4MVM

RECOMMENDED CUTTING CONDITIONS

SIDE MILLING

Material	DC	n	Vc	f	ap	ae	
P Mild steel, Carbon steel, Alloy steel (180 – 280HB),	4	9500	120	1400	6	1.2	
	5	7600	120	1400	7.5	1.5	
	6	6400	120	1400	9	1.8	
	8	4800	120	1300	12	2.4	
	10	3800	120	1200	15	3	
	12	3200	120	1000	18	3.6	
	Pre-hardened steel (≤45HRC), Alloy tool steel	4	5600	70	490	4	0.4
		5	4500	70	500	5	0.5
		6	3700	70	500	6	0.6
		8	2800	70	520	8	0.8
		10	2200	70	460	10	1
		12	1900	70	450	12	1
M Austenitic stainless steel, Ferritic and martensitic stainless steel,	4	6400	80	470	4	0.6	
	5	5100	80	470	5	0.9	
	6	4200	80	580	6	1.2	
S Titanium alloy	8	3200	80	630	8	1.5	
	10	2500	80	660	10	1.8	
M Precipitation hardening stainless steel, Cobalt chromium alloy	12	2100	80	610	12	2.4	
	4	5600	70	490	4	0.8	
	5	4500	70	500	5	1	
	6	3700	70	500	6	1.2	
	8	2800	70	520	8	1.6	
S Heat resistant alloy	10	2200	70	460	10	2	
	12	1900	70	450	12	2.4	
	4	2400	30	120	4	0.4	
	5	1900	30	120	5	0.5	
	6	1600	30	130	6	0.6	
	8	1200	30	130	8	0.8	
10	950	30	140	10	1		
12	800	30	140	12	1.2		

1/1



1. SMART MIRACLE coating has very low electrical conductivity; therefore, an external contact type of tool setter (electrically transmitted) may not work.
When measuring the tool length, please use an internal contact type (non-electrical type) or a laser tool setter.
2. When cutting austenitic stainless steels and titanium alloys, the use of water-soluble cutting fluid is effective.
3. If the depth of cut is shallow, the revolution and feed rate can be increased.
4. If the rigidity of the machine or the work materials installation is very low, or chattering and noise are generated, reduce the revolution and feed rate proportionately.

VQ4MVM

SLOT MILLING AND RAMPING

Material	DC	n	Vc	f	ap	ae	
P Mild steel, Carbon steel, Alloy steel (180 – 280HB)	4	8000	100	840	4	4	
	5	6400	100	840	5	5	
	6	5300	100	840	6	6	
	8	4000	100	740	8	8	
	10	3200	100	680	10	10	
	12	2700	100	570	12	12	
	Pre-hardened steel (≤45HRC), Alloy tool steel	4	4800	60	210	2	4
		5	3800	60	210	2.5	5
		6	3200	60	230	3	6
		8	2400	60	240	4	8
		10	1900	60	270	5	10
		12	1600	60	260	6	12
M Austenitic stainless steel, Ferritic and martensitic stainless steel, Titanium alloy	4	4800	60	280	4	4	
	5	3800	60	280	5	5	
	6	3200	60	300	6	6	
	8	2400	60	320	8	8	
	10	1900	60	350	10	10	
S Precipitation hardening stainless steel, Cobalt chromium alloy	4	4000	50	250	2	4	
	5	3200	50	250	2.5	5	
	6	2700	50	290	3	6	
	8	2000	50	260	4	8	
	10	1600	50	230	5	10	
S Heat resistant alloy	4	2000	25	93	1.2	4	
	5	1600	25	95	1.5	5	
	6	1300	25	96	1.8	6	
	8	990	25	100	2.4	8	
	10	800	25	120	3	10	
	12	660	25	110	3.6	12	

1/1

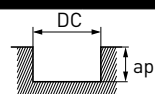

1. SMART MIRACLE coating has very low electrical conductivity; therefore, an external contact type of tool setter (electric transmitted) may not work.
When measuring the tool length, please use an internal contact type (non-electricity type) or a laser tool setter.
2. When cutting austenitic stainless steels and titanium alloys, the use of water-soluble cutting fluid is effective.
3. When performing machining with a strong ramping angle, a high clamping force tool holder is recommended.
4. When performing ramping deeper than the recommended depth of cut, please divide the process into multiple steps within the recommended depth of cut.
5. If the rigidity of the machine or the work materials installation is very low, or chattering and noise are generated, reduce the revolution and feed rate proportionately.

VQ4MVM

FEED RATE FACTOR FOR RAMPING

Material	DC	Slot milling feed %						
		1°	5°	10°	15°	20°	25°	30°
P Mild steel, Carbon steel, Alloy steel (180 – 280HB), Pre-hardened steel (≤45HRC), Alloy tool steel	4	100	90	80	80	60	60	60
	5	100	90	80	80	60	60	60
	6	100	90	80	80	60	60	60
	8	100	95	90	90	90	75	75
	10	100	95	95	95	90	80	80
	12	100	95	95	95	90	80	80
	4	80	70	60				
	5	80	70	60				
	6	80	70	60				
	8	70	60	50				
	10	70	60	50				
	12	70	60	50				
M Austenitic stainless steel, Ferritic and martensitic stainless steel, Titanium alloy	4	90	80	70	50			
	5	90	80	70	50			
	6	90	80	70	60			
	8	90	80	70	60			
	10	80	70	60	50			
	12	80	70	60	50			
M Precipitation hardening stainless steel, Cobalt chromium alloy	4	90	80	70	60	60		
	5	90	80	70	60	60		
	6	90	80	70	60	60		
	8	90	80	70	60	60		
	10	80	80	70	60	60		
	12	80	80	70	60	60		
S Heat resistant alloy	4	90	80					
	5	90	80					
	6	90	80					
	8	90	80					
	10	80	70					
	12	80	70					

1/1



1. SMART MIRACLE coating has very low electrical conductivity; therefore, an external contact type of tool setter (electric transmitted) may not work.
When measuring the tool length, please use an internal contact type (non-electrical type) or a laser tool setter.
2. When performing ramping, please use the feed rate shown on the previous page multiplied by the coefficient.
3. When cutting austenitic stainless steels and titanium alloys, the use of water-soluble cutting fluid is effective.
4. When performing machining with large ramping angles, a high clamping force tool holder is recommended.
Also, if the machine or workpiece material lacks rigidity, or if chipping occurs on the cutting edge, adjust the ramping angle and feed rate.
5. When performing ramping deeper than the recommended depth of cut, please divide the process into multiple steps within the recommended depth of cut.

VQMHV

37°
40°

END MILL, MEDIUM CUT LENGTH, 4 FLUTE, IRREGULAR HELIX FLUTES, OFFSET TYPES FOR VERTICAL WALL MACHINING AND DEEP APPLICATIONS

P M N S

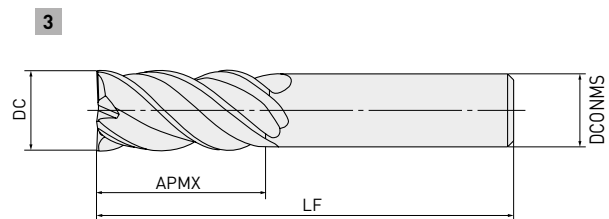
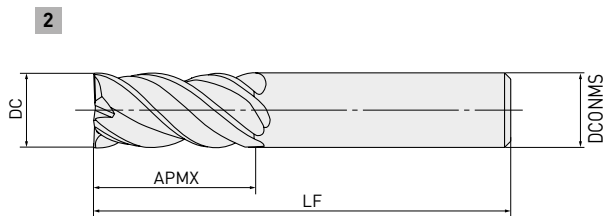
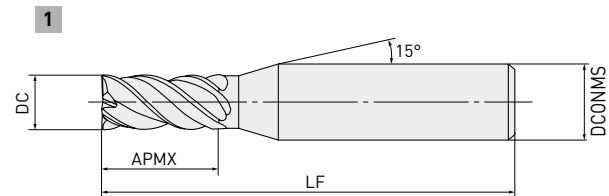

	DC < 12	DC > 12		
	0	0		
	-0.020	-0.030		
	4 < D4 < 6	8 < D4 < 10	12 < D4 < 16	20 < D4 < 25
	0	0	0	0
	-0.008	-0.009	-0.011	-0.013



- VQ vibration control end mills for reduced chattering, a stable performance on difficult-to-cut materials and long overhang applications.

Order number	Stock	DC	APMX	LF	DCONMS	ZEFP	Type
VQMHVD0100	●	1	2	45	4	4	1
VQMHVD0150	●	1.5	3	45	4	4	1
VQMHVD0200	●	2	4	45	4	4	1
VQMHVD0250	●	2.5	5	45	4	4	1
VQMHVD0300	●	3	8	45	6	4	1
VQMHVD0350	●	3.5	8	45	6	4	1
VQMHVD0400	●	4	11	45	6	4	1
VQMHVD0500	●	5	13	50	6	4	1
VQMHVD0600	●	6	13	50	6	4	2
VQMHVD0700	●	7	19	60	8	4	1
VQMHVD0800	●	8	19	60	8	4	2
VQMHVD0900	●	9	22	70	10	4	1
VQMHVD0900S08	●	9	22	75	8	4	3
VQMHVD1000	●	10	22	70	10	4	2
VQMHVD1000S08	●	10	22	100	8	4	3
VQMHVD1100	●	11	26	75	12	4	1

1/2

VQMHV – END MILL, MEDIUM CUT LENGTH, 4 FLUTE, IRREGULAR HELIX FLUTES, OFFSET TYPES FOR VERTICAL WALL MACHINING AND DEEP APPLICATIONS

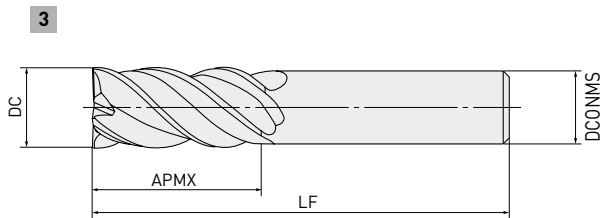
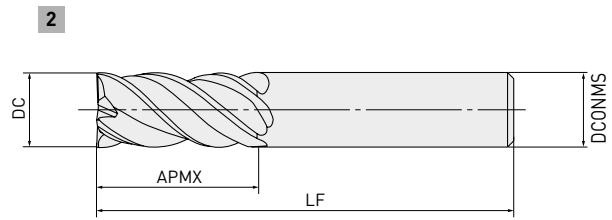
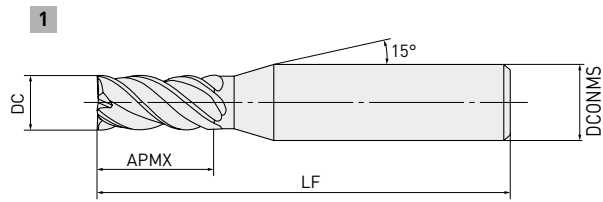

Order number	Stock	DC	APMX	LF	DCONMS	ZEFP	Type
VQMHVD1100S10	●	11	26	100	10	4	3
VQMHVD1200	●	12	26	75	12	4	2
VQMHVD1200S10	●	12	26	110	10	4	3
VQMHVD1300	●	13	26	75	12	4	3
VQMHVD1300S12	●	13	26	110	12	4	3
VQMHVD1400	●	14	30	90	16	4	1
VQMHVD1400S12	●	14	32	130	12	4	3
VQMHVD1600	●	16	35	90	16	4	2
VQMHVD1800	●	18	40	100	16	4	3
VQMHVD1800S16	●	18	42	150	16	4	3
VQMHVD2000	●	20	45	110	20	4	2
VQMHVD2500	●	25	55	125	25	4	2

2/2

VQMHV

RECOMMENDED CUTTING CONDITIONS

SHOULDER MILLING

HIGH EFFICIENCY CUTTING CONDITIONS

Material	DC	n	Vf	ap	ae
P Carbon steel, Alloy steel, Mild steel	2	24000	2400	3	0.6
	3	16000	2600	4.5	0.9
	4	12000	2600	6	1.2
	5	9500	2500	7.5	1.5
	6	8000	2600	9	1.8
	8	6000	2500	12	2.4
	10	4800	2300	15	3
	12	4000	1900	18	3.6
	16	3000	1600	24	4.8
	20	2400	1300	30	6
P Pre-hardened steel, Carbon steel, Alloy steel, Alloy tool steel	25	1900	1100	37	7.5
	2	19000	1100	3	0.6
	3	13000	1200	4.5	0.9
	4	9500	1300	6	1.2
	5	7600	1300	7.5	1.5
	6	6400	1300	9	1.8
	8	4800	1300	12	2.4
	10	3800	1200	15	3
	12	3200	1200	18	3.6
	16	2400	960	24	4.8
M Austenitic, Ferritic and martensitic stainless steel, Titanium alloy	20	1900	760	30	6
	25	1500	600	37	7.5
	2	16000	830	3	0.6
	3	11000	880	4.5	0.9
	4	8000	900	6	1.2
	5	6400	900	7.5	1.5
	6	5300	1100	9	1.8
	8	4000	1200	12	2.4
	10	3200	1300	15	3
	12	2700	1200	18	3.6
S Hardened stainless steel, Cobalt chromium alloy	16	2000	960	24	4.8
	20	1600	770	30	6
	25	1300	620	37	7.5
	2	12000	720	3	0.4
	3	8000	770	4.5	0.6
	4	6000	790	6	0.8
M Hardened stainless steel, Cobalt chromium alloy	5	4800	810	7.5	1
	6	4000	800	9	1.2
	8	3000	840	12	1.6
	10	2400	770	15	2
	12	2000	720	18	2.4
	16	1500	600	24	3.2
	20	1200	480	30	4
	25	950	380	37	5

1/1



VQMHV

GENERAL PURPOSE CUTTING CONDITIONS

Material	DC	n	Vf	ap	ae
Carbon steel, Alloy steel, Mild steel	2	19000	1300	3	0.6
	3	13000	1400	4.5	0.9
	4	9500	1400	6	1.2
	5	7600	1300	7.5	1.5
	6	6400	1400	9	1.8
	8	4800	1300	12	2.4
	10	3800	1200	15	3
	12	3200	1000	18	3.6
	16	2400	860	24	4.8
	20	1900	680	30	6
Pre-hardened steel, Carbon steel, Alloy steel, Alloy tool steel	25	1500	390	37.5	7.5
	2	16000	630	3	0.6
	3	11000	700	4.5	0.9
	4	8000	700	6	1.2
	5	6400	710	7.5	1.5
	6	5300	700	9	1.8
	8	4000	740	12	2.4
	10	3200	680	15	3
	12	2700	640	18	3.6
	16	2000	530	24	4.8
Austenitic, Ferritic and martensitic stainless steel, Titanium alloy	20	1600	420	30	6
	25	1300	340	37.5	7.5
	2	13000	450	1.5	0.2
	3	8500	450	2.25	0.3
	4	6400	470	3	0.6
	5	5100	470	4.5	0.9
	6	4200	580	6	1.2
	8	3200	630	7.5	1.5
	10	2500	660	9	1.8
	12	2100	610	12	2.4
Hardened stainless steel, Cobalt chromium alloy	16	1600	510	15	3
	20	1300	410	18	3.6
	25	1000	210	24	4.8
	2	11000	440	3	0.4
	3	7400	470	4.5	0.6
	4	5600	490	6	0.8
	5	4500	500	7.5	1
	6	3700	490	9	1.2
	8	2800	520	12	1.6
	10	2200	460	15	2
	12	1900	450	18	2.4
	16	1400	370	24	3.2
	20	1100	290	30	4
	25	890	230	37.5	5

1/1



1. SMART MIRACLE coating has very low electrical conductivity; therefore, an electrical contact type of tool setter may not work. When measuring the tool length, please use a mechanical contact type or a laser tool setter.
2. Effective machining of stainless steel, titanium alloys and heat-resistant alloys etc. can be achieved with the use of emulsion coolant.
3. Chattering can still occur if the machine rigidity and clamping method are insufficient. In these cases the feed and speed should be reduced proportionately.
4. When the depth of cut is smaller than shown the revolution and feed rate can be increased.

VQMHV

SHOULDER MILLING

HIGH EFFICIENCY CUTTING CONDITIONS

Material	DC	n	Vf	ap	ae
N Copper, Copper alloy	2	29000	2900	3	0.6
	3	19000	3000	4.5	0.9
	4	14000	3100	6	1.2
	5	11000	2900	7.5	1.5
	6	9500	3000	9	1.8
	8	7200	3000	12	2.4
	10	5700	2700	15	3
	12	4800	2300	18	3.6
	16	3600	1900	24	4.8
	20	2900	1600	30	6
	25	2300	1300	37	7.5
S Heat resistant alloy	2	6400	230	3	0.2
	3	4200	240	4.5	0.3
	4	3200	240	6	0.4
	5	2500	240	7.5	0.5
	6	2100	250	9	0.6
	8	1600	260	12	0.8
	10	1300	290	15	1
	12	1100	280	18	1.2
	16	800	200	24	1.6
	20	640	160	30	2
	25	510	130	37.5	2.5

1/1



VQMHV

GENERAL PURPOSE CUTTING CONDITIONS

Material	DC	n	Vf	ap	ae
N Copper, Copper alloy	2	22000	1500	3	0.6
	3	15000	1600	4.5	0.9
	4	11000	1600	6	1.2
	5	8900	1500	7.5	1.5
	6	7400	1600	9	1.8
	8	5600	1600	12	2.4
	10	4500	1400	15	3
	12	3700	1200	18	3.6
	16	2800	1000	24	4.8
	20	2200	780	30	6
	25	1800	670	37.5	7.5
S Heat resistant alloy	2	4800	110	3	0.2
	3	3200	120	4.5	0.3
	4	2400	120	6	0.4
	5	1900	120	7.5	0.5
	6	1600	130	9	0.6
	8	1200	130	12	0.8
	10	950	140	15	1
	12	800	140	18	1.2
	16	600	100	24	1.6
	20	480	81	30	2
	25	380	64	37.5	2.5

1/1



1. SMART MIRACLE coating has very low electrical conductivity; therefore, an electrical contact type of tool setter may not work. When measuring the tool length, please use a mechanical contact type or a laser tool setter.
2. Effective machining of stainless steel, titanium alloys and heat-resistant alloys etc. can be achieved with the use of emulsion coolant.
3. Chattering can still occur if the machine rigidity and clamping method are insufficient. In these cases the feed and speed should be reduced proportionately.
4. When the depth of cut is smaller than shown the revolution and feed rate can be increased.

VQMHV

SLOTTING

HIGH EFFICIENCY CUTTING CONDITIONS

Material	DC	n	Vf	ap
P Carbon steel, Alloy steel, Mild steel	2	24000	1200	2
	3	16000	1500	3
	4	12000	1900	4
	5	9500	1900	5
	6	8000	1900	6
	8	6000	1700	8
	10	4800	1500	10
	12	4000	1300	12
	16	3000	1100	12
	20	2400	860	12
P Pre-hardened steel, Carbon steel, Alloy steel, Alloy tool steel	25	1900	760	12
	2	19000	610	2
	3	13000	730	3
	4	9500	910	4
	5	7600	910	5
	6	6400	1000	6
	8	4800	960	8
	10	3800	840	10
	12	3200	770	12
	16	2400	670	12
M Austenitic, Ferritic and martensitic stainless steel, Titanium alloy	20	1900	530	12
	25	1500	420	12
	2	16000	640	2
	3	11000	660	3
	4	8000	700	4
	5	6400	720	5
	6	5300	740	6
	8	4000	800	8
	10	3200	900	10
	12	2700	860	12
S Hardened stainless steel, Cobalt chromium alloy	16	2000	640	12
	20	1600	510	12
	25	1300	420	12
	2	9500	300	1
	3	6400	360	1.5
M Hardened stainless steel, Cobalt chromium alloy	4	4800	460	2
	5	3800	460	2.5
	6	3200	510	3
	8	2400	480	4
	10	1900	420	5
	12	1600	380	6
	16	1200	340	8
	20	950	270	10
	25	760	210	12

VQMHV – SLOTTING – HIGH EFFICIENCY CUTTING CONDITIONS

Material	DC	n	Vf	ap
N Copper, Copper alloy	2	29000	1500	2
	3	19000	1700	3
	4	14000	2200	4
	5	11000	2200	5
	6	9500	2300	6
	8	7200	2000	8
	10	5700	1800	10
	12	4800	1500	12
	16	3600	1300	12
	20	2900	1000	12
S Heat resistant alloy	25	2300	920	12
	2	4800	130	0.6
	3	3200	150	0.9
	4	2400	170	1.2
	5	1900	170	1.5
	6	1600	180	1.8
	8	1200	190	2.4
	10	950	210	3
	12	800	200	3.6
	16	600	150	4.8
20	480	120	6	
25	380	100	7.5	

2/2

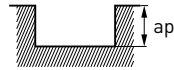

VQMHV

GENERAL PURPOSE CUTTING CONDITIONS

Material	DC	n	Vf	ap
Carbon steel, Alloy steel, Mild steel	2	16000	550	2
	3	11000	670	3
	4	8000	840	4
	5	6400	840	5
	6	5300	840	6
	8	4000	740	8
	10	3200	680	10
	12	2700	570	12
	16	2000	480	12
	20	1600	380	12
Pre-hardened steel, Carbon steel, Alloy steel, Alloy tool steel	25	1300	340	12
	2	13000	270	2
	3	8500	310	3
	4	6400	410	4
	5	5100	400	5
	6	4200	440	6
	8	3200	420	8
	10	2500	360	10
	12	2100	330	12
	16	1600	300	12
Austenitic, Ferritic and martensitic stainless steel, Titanium alloy	20	1300	240	12
	25	1000	180	12
	2	9500	250	2
	3	6400	250	3
	4	4800	280	4
	5	3800	280	5
	6	3200	300	6
	8	2400	320	8
	10	1900	350	10
	12	1600	340	12
Hardened stainless steel, Cobalt chromium alloy	16	1200	250	12
	20	950	200	12
	25	760	160	12
	2	8000	170	1
	3	5300	200	1.5
	4	4000	250	2
	5	3200	250	2.5
	6	2700	290	3
	8	2000	260	4
	10	1600	230	5
	12	1300	210	6
	16	990	180	8
	20	800	150	10
	25	640	120	12

VQMHV – GENERAL PURPOSE CUTTING CONDITIONS

Material	DC	n	Vf	ap
N Copper, Copper alloy	2	19000	650	2
	3	13000	790	3
	4	9500	1000	4
	5	7600	1000	5
	6	6400	1000	6
	8	4800	890	8
	10	3800	800	10
	12	3200	680	12
	16	2400	570	12
	20	1900	450	12
	25	1500	400	12
S Heat resistant alloy	2	4000	74	0.6
	3	2700	86	0.9
	4	2000	93	1.2
	5	1600	95	1.5
	6	1300	96	1.8
	8	990	100	2.4
	10	800	120	3
	12	660	110	3.6
	16	500	84	4.8
	20	400	68	6
	25	320	50	7.5

2/2

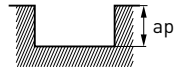

1. SMART MIRACLE coating has very low electrical conductivity; therefore, an electrical contact type of tool setter may not work. When measuring the tool length, please use a mechanical contact type or a laser tool setter.
2. Effective machining of stainless steel, titanium alloys and heat-resistant alloys etc. can be achieved with the use of emulsion coolant.
3. Chattering can still occur if the machine rigidity and clamping method are insufficient. In these cases the feed and speed should be reduced proportionately.
4. When the depth of cut is smaller than shown the revolution and feed rate can be increased.

VQJHV

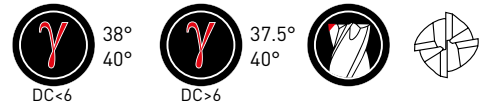

END MILL, SEMI-LONG CUT LENGTH, 4 FLUTE, IRREGULAR HELIX FLUTES

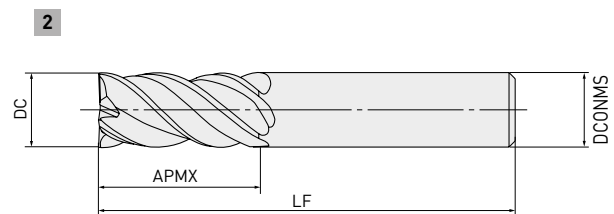
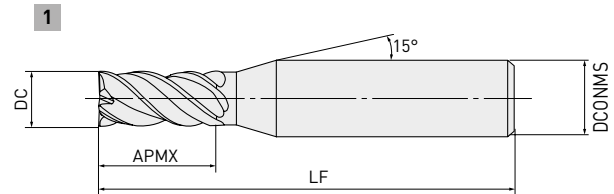

	DC <12	DC >12		
	0 -0.020	0 -0.030		
	D4 = 6	8 < D4 < 10	12 < D4 < 16	D4 = 20
	0 -0.008	0 -0.009	0 -0.011	0 -0.013

- VQ vibration control end mills for reduced chattering, a stable performance on difficult-to-cut materials and long overhang applications.

Order number	Stock	DC	APMX	LF	DCONMS	ZEFP	Type
VQJHVD0100	●	1	4	45	4	4	1
VQJHVD0150	●	1.5	6	45	4	4	1
VQJHVD0200	●	2	8	60	6	4	1
VQJHVD0250	●	2.5	10	60	6	4	1
VQJHVD0300	●	3	12	60	6	4	1
VQJHVD0350	●	3.5	14	60	6	4	1
VQJHVD0400	●	4	16	60	6	4	1
VQJHVD0450	●	4.5	18	60	6	4	1
VQJHVD0500	●	5	20	60	6	4	1
VQJHVD0600	●	6	24	60	6	4	2
VQJHVD0700	●	7	25	80	8	4	1
VQJHVD0800	●	8	28	80	8	4	2
VQJHVD0900	●	9	32	90	10	4	1
VQJHVD1000	●	10	35	90	10	4	2
VQJHVD1200	●	12	40	100	12	4	2
VQJHVD1600	●	16	55	125	16	4	2
VQJHVD2000	●	20	70	140	20	4	2

1/1



VQJHV

RECOMMENDED CUTTING CONDITIONS

SHOULDER MILLING

Material	DC	n	Vf	ap	ae
P Carbon steel, Alloy steel, Mild steel	2	21000	700	5	0.2
	3	14000	960	7.5	0.3
	4	10000	1000	10	0.4
	5	8300	1100	12.5	0.5
	6	6900	1200	15	0.6
	8	5200	1200	20	0.8
	10	4100	1100	25	1
	12	3400	1100	30	1.2
	16	2600	920	40	1.6
	20	2100	820	50	2
Pre-hardened steel, Carbon steel, Alloy steel, Alloy tool steel	2	16000	510	5	0.2
	3	11000	680	7.5	0.3
	4	8000	690	10	0.4
	5	6400	730	12.5	0.5
	6	5300	810	15	0.6
	8	4000	840	20	0.8
	10	3200	810	25	1
	12	2700	780	30	1.2
	16	2000	640	40	1.6
	20	1600	570	50	2
M Austenitic, Ferritic and martensitic stainless steel, Titanium alloy	2	13000	390	5	0.1
	3	8500	490	7.5	0.15
	4	6400	540	10	0.2
	5	5100	570	12.5	0.25
	6	4200	630	15	0.3
	8	3200	640	20	0.4
	10	2500	590	25	0.5
	12	2100	550	30	0.6
	16	1600	450	40	0.8
	20	1300	420	50	1
S Hardened stainless steel, Cobalt chromium alloy	2	12000	360	5	0.1
	3	8000	460	7.5	0.15
	4	6000	510	10	0.2
	5	4800	540	12.5	0.25
	6	4000	600	15	0.3
	8	3000	600	20	0.4
	10	2400	570	25	0.5
	12	2000	520	30	0.6
	16	1500	420	40	0.8
	20	1200	390	50	1

1/2



VQJHV – SHOULDER MILLING

Material	DC	n	Vf	ap	ae
N Copper, Copper alloy	2	25000	830	5	0.2
	3	17000	1200	7.5	0.3
	4	13000	1300	10	0.4
	5	10000	1300	12.5	0.5
	6	8500	1500	15	0.6
	8	6400	1500	20	0.8
	10	5100	1300	25	1
	12	4200	1300	30	1.2
	16	3200	1100	40	1.6
	20	2500	970	50	2
S Heat resistant alloy	2	6400	90	5	0.04
	3	4200	130	7.5	0.06
	4	3200	190	10	0.08
	5	2500	180	12.5	0.1
	6	2100	180	15	0.12
	8	1600	170	20	0.16
	10	1300	170	25	0.2
	12	1100	140	30	0.24
	16	800	110	40	0.32
	20	640	80	50	0.4

2/2



1. SMART MIRACLE coating has very low electrical conductivity; therefore, an electrical contact type of tool setter may not work. When measuring the tool length, please use a mechanical contact type or a laser tool setter.
2. Effective machining of stainless steel, titanium alloys and heat-resistant alloys etc. can be achieved with the use of emulsion coolant.
3. Chattering can still occur if the machine rigidity and clamping method are insufficient. In these cases the feed and speed should be reduced proportionately.
4. When the depth of cut is smaller than shown the revolution and feed rate can be increased.

VQSVR



43°



44°

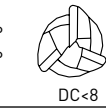

45°



DC < 8

DC > 8

ROUGHING END MILL, SHORT CUT LENGTH, 4 FLUTE, IRREGULAR HELIX FLUTES

P M N S

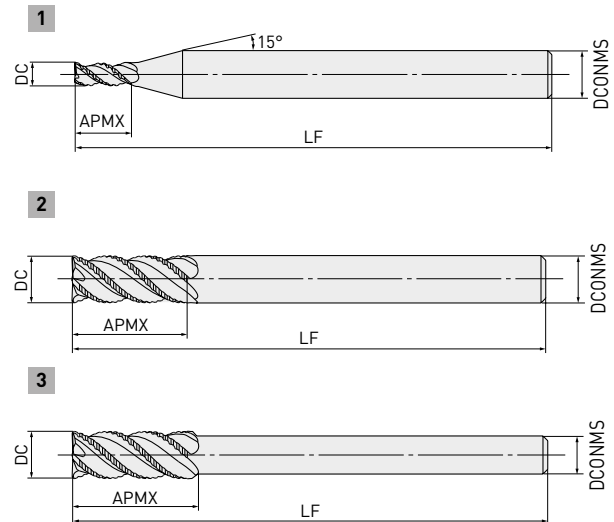

D4 = 6	8 < D4 < 10	12 < D4 < 16	D4 = 20
0	0	0	0
-0.008	-0.009	-0.011	-0.013

- Achieves excellent vibration resistance due to the adoption of irregular helix flutes.

Order number	Stock	DC	APMX	LF	DCONMS	ZEFP	Type
VQSVRD0300	●	3	6	60	6	3	1
VQSVRD0400	●	4	8	60	6	3	1
VQSVRD0500	●	5	10	60	6	3	1
VQSVRD0600	●	6	12	70	6	3	2
VQSVRD0700	●	7	17	80	8	3	1
VQSVRD0800	●	8	17	80	8	4	2
VQSVRD0900	●	9	22	90	10	4	1
VQSVRD1000S08	●	10	22	90	8	4	3
VQSVRD1000	●	10	22	90	10	4	2
VQSVRD1200S10	●	12	27	100	10	4	3
VQSVRD1200	●	12	27	100	12	4	2
VQSVRD1400	●	14	27	130	12	4	3
VQSVRD1600	●	16	33	125	16	4	2
VQSVRD1800	●	18	33	150	16	4	3
VQSVRD2000	●	20	38	140	20	4	2

1/1



VQSVR

RECOMMENDED CUTTING CONDITIONS

SHOULDER MILLING

HIGH EFFICIENCY CUTTING CONDITIONS

Material	DC	n	Vf	ap	ae
Carbon steel, Alloy steel, Mild steel	3	16000	960	4.5	1.5
	4	12000	960	6	2
	5	9500	960	7.5	2.5
	6	8000	960	9	3
	7	6800	950	10.5	3.5
	8	6000	1100	12	4
	9	5300	1100	13.5	4.5
	10	4800	1100	15	5
	12	4000	960	18	6
	14	3400	880	21	7
	16	3000	840	24	8
	18	2700	810	27	9
	20	2400	760	30	10
Pre-hardened steel, Carbon steel, Alloy steel, Alloy tool steel	3	13000	640	4.5	1.5
	4	9500	640	6	2
	5	7600	640	7.5	2.5
	6	6400	680	9	3
	7	5500	730	10.5	3.5
	8	4800	760	12	4
	9	4200	760	13.5	4.5
	10	3800	760	15	5
	12	3200	700	18	6
	14	2700	650	21	7
	16	2400	620	24	8
	18	2100	590	27	9
	20	1900	560	30	10
Austenitic, Ferritic and martensitic stainless steel, Titanium alloy	3	11000	450	4.5	1.5
	4	8000	430	6	2
	5	6400	440	7.5	2.5
	6	5300	480	9	3
	7	4500	500	10.5	3.5
	8	4000	570	12	4
	9	3500	560	13.5	4.5
	10	3200	570	15	5
	12	2700	540	18	6
	14	2300	510	21	7
	16	2000	500	24	8
	18	1800	500	27	9
	20	1600	510	30	10

1/2

VQSVR – SHOULDER MILLING – HIGH EFFICIENCY CUTTING CONDITIONS

Material	DC	n	Vf	ap	ae
M Hardened stainless steel, Cobalt chromium alloy	3	8000	330	4.5	0.9
	4	6000	330	6	1.2
	5	4800	330	7.5	1.5
	6	4000	360	9	1.8
	7	3400	380	10.5	2.1
	8	3000	430	12	2.4
	9	2700	430	13.5	2.7
	10	2400	430	15	3
	12	2000	400	18	3.6
	14	1700	370	21	4.2
	16	1500	380	24	4.8
	18	1300	360	27	5.4
	20	1200	380	30	6
N Copper, Copper alloy	3	19000	1100	4.5	1.5
	4	14000	1100	6	2
	5	11000	1100	7.5	2.5
	6	9500	1100	9	3
	7	8200	1100	10.5	3.5
	8	7200	1300	12	4
	9	6400	1300	13.5	4.5
	10	5700	1200	15	5
	12	4800	1200	18	6
	14	4100	1100	21	7
	16	3600	1000	24	8
	18	3200	960	27	9
	20	2900	920	30	10

2/2



VQSVR

GENERAL PURPOSE CUTTING CONDITIONS

Material	DC	n	Vf	ap	ae	
Carbon steel, Alloy steel, Mild steel	3	13000	620	4.5	1.5	
	4	9500	610	6	2	
	5	7600	610	7.5	2.5	
	6	6400	610	9	3	
	7	5500	620	10.5	3.5	
	8	4800	670	12	4	
	9	4200	670	13.5	4.5	
	10	3800	670	15	5	
	12	3200	610	18	6	
	14	2700	560	21	7	
Pre-hardened steel, Carbon steel, Alloy steel, Alloy tool steel	16	2400	540	24	8	
	18	2100	500	27	9	
	20	1900	480	30	10	
	3	11000	430	4.5	1.5	
	4	8000	430	6	2	
	5	6400	430	7.5	2.5	
	6	5300	450	9	3	
	7	4500	480	10.5	3.5	
	8	4000	510	12	4	
	9	3500	500	13.5	4.5	
Austenitic, Ferritic and martensitic stainless steel, Titanium alloy	10	3200	510	15	5	
	12	2700	470	18	6	
	14	2300	440	21	7	
	16	2000	410	24	8	
	18	1800	400	27	9	
	20	1600	380	30	10	
	M	3	8500	280	4.5	1.5
		4	6400	280	6	2
		5	5100	280	7.5	2.5
		6	4200	300	9	3
7		3600	320	10.5	3.5	
8		3200	360	12	4	
9		2800	360	13.5	4.5	
10		2500	360	15	5	
12		2100	340	18	6	
S		14	1800	320	21	7
	16	1600	320	24	8	
	18	1400	310	27	9	
	20	1300	330	30	10	

1/2

VQSVR – GENERAL PURPOSE CUTTING CONDITIONS

Material	DC	n	Vf	ap	ae
M Hardened stainless steel, Cobalt chromium alloy	3	7400	240	4.5	0.9
	4	5600	240	6	1.2
	5	4500	250	7.5	1.5
	6	3700	270	9	1.8
	7	3200	290	10.5	2.1
	8	2800	320	12	2.4
	9	2500	320	13.5	2.7
	10	2200	310	15	3
	12	1900	300	18	3.6
	14	1600	280	21	4.2
	16	1400	280	24	4.8
	18	1200	270	27	5.4
20	1100	280	30	6	
N Copper, Copper alloy	3	15000	720	4.5	1.5
	4	11000	700	6	2
	5	8900	720	7.5	2.5
	6	7400	710	9	3
	7	6400	720	10.5	3.5
	8	5600	780	12	4
	9	5000	800	13.5	4.5
	10	4500	790	15	5
	12	3700	710	18	6
	14	3200	670	21	7
	16	2800	630	24	8
	18	2500	600	27	9
20	2200	560	30	10	

2/2



1. SMART MIRACLE coating has very low electrical conductivity; therefore, an electrical contact type of tool setter may not work.
When measuring the tool length, please use a mechanical contact type or a laser tool setter.
2. Effective machining of stainless steel, titanium alloys and heat-resistant alloys etc. can be achieved with the use of emulsion coolant.
3. Chattering can still occur if the machine rigidity and clamping method are insufficient.
In these cases the feed and speed should be reduced proportionately.
4. When the depth of cut is smaller than shown the revolution and feed rate can be increased.

VQSVR

SLOTTING

HIGH EFFICIENCY CUTTING CONDITIONS

Material	DC	n	Vf	ap
P Carbon steel, Alloy steel, Mild steel	3	13000	720	3
	4	9500	720	4
	5	7600	720	5
	6	6400	720	6
	7	5500	770	7
	8	4800	800	8
	9	4200	810	9
	10	3800	800	10
	12	3200	750	12
	14	2700	670	14
	16	2400	620	16
	18	2100	570	18
	20	1900	540	20
Pre-hardened steel, Carbon steel, Alloy steel, Alloy tool steel	3	11000	440	3
	4	8000	450	4
	5	6400	460	5
	6	5300	450	6
	7	4500	470	7
	8	4000	480	8
	9	3500	490	9
	10	3200	520	10
	12	2700	480	12
	14	2300	420	14
	16	2000	380	16
	18	1800	380	18
	20	1600	350	20
M Austenitic, Ferritic and martensitic stainless steel, Titanium alloy	3	8500	340	3
	4	6400	340	4
	5	5100	300	5
	6	4200	310	6
	7	3600	330	7
	8	3200	350	8
	9	2800	350	9
	10	2500	340	10
	12	2100	340	12
	14	1800	300	14
	16	1600	290	16
	18	1400	260	18
	20	1300	260	20
S				

VQSVR – SLOTTING – HIGH EFFICIENCY CUTTING CONDITIONS

Material	DC	n	Vf	ap
M Hardened stainless steel, Cobalt chromium alloy	3	6400	250	1.5
	4	4800	250	2
	5	3800	230	2.5
	6	3200	240	3
	7	2700	250	3.5
	8	2400	260	4
	9	2100	260	4.5
	10	1900	260	5
	12	1600	260	6
	14	1400	240	7
	16	1200	220	8
	18	1100	210	9
	20	950	190	10
N Copper, Copper alloy	3	16000	890	3
	4	12000	910	4
	5	9500	900	5
	6	8000	900	6
	7	6800	950	7
	8	6000	1000	8
	9	5300	1000	9
	10	4800	1000	10
	12	4000	940	12
	14	3400	840	14
	16	3000	780	16
18	2700	730	18	
20	2400	680	20	

2/2

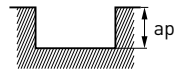

VQSVR

GENERAL PURPOSE CUTTING CONDITIONS

Material	DC	n	Vf	ap
P Carbon steel, Alloy steel, Mild steel	3	11000	490	3
	4	8000	490	4
	5	6400	490	5
	6	5300	480	6
	7	4500	500	7
	8	4000	530	8
	9	3500	540	9
	10	3200	540	10
	12	2700	510	12
	14	2300	460	14
	16	2000	410	16
	18	1800	390	18
	20	1600	360	20
P Pre-hardened steel, Carbon steel, Alloy steel, Alloy tool steel	3	8500	300	3
	4	6400	310	4
	5	5100	310	5
	6	4200	300	6
	7	3600	320	7
	8	3200	330	8
	9	2800	330	9
	10	2500	330	10
	12	2100	320	12
	14	1800	300	14
	16	1600	290	16
	18	1400	260	18
	20	1300	260	20
M S Austenitic, Ferritic and martensitic stainless steel, Titanium alloy	3	6400	200	3
	4	4800	200	4
	5	3800	180	5
	6	3200	190	6
	7	2700	200	7
	8	2400	210	8
	9	2100	210	9
	10	1900	210	10
	12	1600	210	12
	14	1400	190	14
	16	1200	170	16
	18	1100	170	18
	20	950	150	20

VQSVR – GENERAL PURPOSE CUTTING CONDITIONS

Material	DC	n	Vf	ap
M Hardened stainless steel, Cobalt chromium alloy	3	5300	170	1.5
	4	4000	170	2
	5	3200	150	2.5
	6	2700	160	3
	7	2300	170	3.5
	8	2000	180	4
	9	1800	180	4.5
	10	1600	180	5
	12	1300	170	6
	14	1100	150	7
	16	990	140	8
	18	880	130	9
	20	800	130	10
N Copper, Copper alloy	3	13000	580	3
	4	9500	580	4
	5	7600	580	5
	6	6400	580	6
	7	5500	620	7
	8	4800	640	8
	9	4200	650	9
	10	3800	640	10
	12	3200	600	12
	14	2700	540	14
	16	2400	500	16
	18	2100	460	18
	20	1900	430	20

2/2

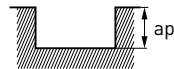

1. SMART MIRACLE coating has very low electrical conductivity; therefore, an electrical contact type of tool setter may not work. When measuring the tool length, please use a mechanical contact type or a laser tool setter.
2. Effective machining of stainless steel, titanium alloys and heat-resistant alloys etc. can be achieved with the use of emulsion coolant.
3. Chattering can still occur if the machine rigidity and clamping method are insufficient. In these cases the feed and speed should be reduced proportionately.
4. When the depth of cut is smaller than shown the revolution and feed rate can be increased.

VQN2MB



BALL NOSE, MEDIUM CUT LENGTH, 2 FLUTE

S

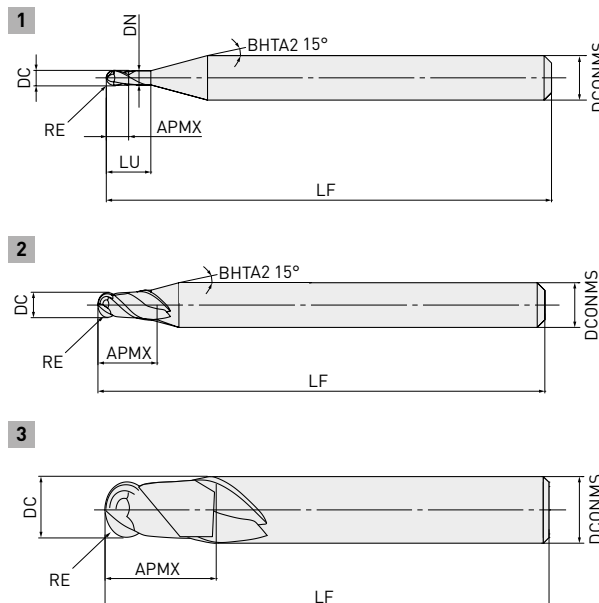

	RE ≤ 6
	±0.010
	DCONMS=6 8 < DCONMS < 10 DCONMS=12
	0 0 0
	-0.005 -0.006 -0.008

- The (Al, Ti, Si) N-based coating provides excellent wear and chipping resistance when machining heat resistant super alloys.
- The R cutting edge rake angle and ball nose geometry have been optimised to improve strength.

Order number	Stock	DC	RE	APMX	LF	LU	DN	DCONMS	ZEFP	Type
VQN2MBR0050	●	1	0.5	1	60	4	0.94	6	2	1
VQN2MBR0100	●	2	1.0	2	60	6	1.9	6	2	1
VQN2MBR0150	●	3	1.5	3	60	8	2.9	6	2	1
VQN2MBR0200	●	4	2.0	8	60	—	—	6	2	2
VQN2MBR0250	●	5	2.5	12	60	—	—	6	2	2
VQN2MBR0300	●	6	3.0	12	60	—	—	6	2	3
VQN2MBR0400	●	8	4.0	14	70	—	—	8	2	3
VQN2MBR0500	●	10	5.0	18	80	—	—	10	2	3
VQN2MBR0600	●	12	6.0	22	80	—	—	12	2	3

1/1



VQN2MB

RECOMMENDED CUTTING CONDITIONS

Material	RE	$\alpha \leq 15^\circ$		$\alpha > 15^\circ$		ap	ae
		n	f	n	f		
S Nickel-based heat resistant super alloy Inconel®718, Inconel®713C, WASPALLOY® etc.	0.5	12700	640	12700	760	0.1	0.25
	1.0	6300	320	6300	380	0.2	0.50
	1.5	4200	250	4200	250	0.3	0.75
	2.0	3100	190	3100	220	0.4	1.00
	2.5	2500	180	2500	200	0.5	1.25
	3.0	2100	170	2100	210	0.6	1.50
	4.0	1500	130	1500	160	0.8	2.00
	5.0	1200	130	1200	140	1.0	2.50
	6.0	1000	110	1000	120	1.2	3.00

1/1

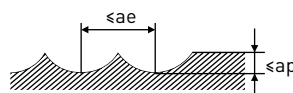

1. For machining heat resistant super alloys, the use of water-soluble coolant is effective.
2. If the depth of cut is shallow, the revolution and feed rate can be increased.
3. Vibration may occur if the rigidity of machine or workpiece is low. In this case, please reduce the revolution and feed rate proportionately.
4. α is the inclination angle of the machined surface.

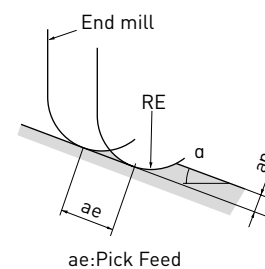

VQ2XLB



30°



DC≤6

BALL NOSE, SHORT CUT LENGTH, 2 FLUTE, LONG NECK

S

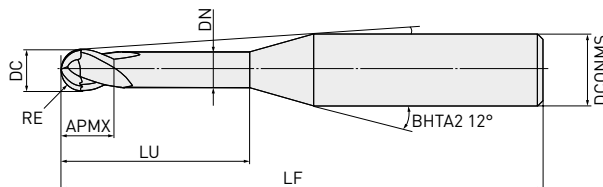

$0.5 \leq RE \leq 1.5$

± 0.005



$4 \leq DCONMS \leq 6$

0

-0.005

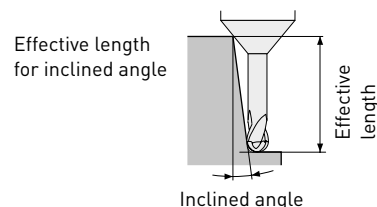

- SMART MIRACLE coating providing better wear resistance when machining difficult-to-cut materials.

Order number	Stock	DC	RE	APMX	LF	LU	DN	BHTA2	B2	DCONMS	ZEFP
VQ2XLB0050N080	●	1	0.5	0.75	50	8	0.94	15°	6.4	4	
VQ2XLB0050N100	●	1	0.5	0.75	50	10	0.94	15°	5.6	4	
VQ2XLB0050N080S06	●	1	0.5	0.75	50	8	0.94	15°	8.3	6	
VQ2XLB0050N100S06	●	1	0.5	0.75	55	10	0.94	15°	7.5	6	
VQ2XLB0050N120S06	●	1	0.5	0.75	55	12	0.94	15°	6.8	6	
VQ2XLB0075N100S06	●	1.5	0.75	1.13	55	10	1.44	15°	7.2	6	
VQ2XLB0075N120S06	●	1.5	0.75	1.13	55	12	1.44	15°	6.5	6	
VQ2XLB0100N100	●	2	1	1.5	50	10	1.9	15°	4.5	4	2
VQ2XLB0100N100S06	●	2	1	1.5	55	10	1.9	15°	6.9	6	
VQ2XLB0100N120	●	2	1	1.5	50	12	1.9	15°	3.9	4	
VQ2XLB0100N120S06	●	2	1	1.5	55	12	1.9	15°	6.1	6	
VQ2XLB0150N120	●	3	1.5	2.3	55	12	2.9	15°	5.3	6	
VQ2XLB0150N140	●	3	1.5	2.3	60	14	2.9	15°	4.7	6	
VQ2XLB0150N160	●	3	1.5	2.3	60	16	2.9	15°	4.3	6	

1/1



VQ2XLB

RECOMMENDED CUTTING CONDITIONS

Material	RE	LU	n	Vc	Vf	ap	ae
Titanium alloy	0.5	8	32000	100	2500	0.05	0.1
	0.5	10	24000	75	1500	0.05	0.1
	0.5	12	24000	75	1500	0.03	0.1
	0.75	10	21000	100	2100	0.13	0.3
	0.75	12	16000	75	1500	0.13	0.3
	1	10	16000	100	1800	0.20	0.5
	1	12	16000	100	1800	0.20	0.5
	1.5	12	10000	100	1600	0.30	0.8
	1.5	14	10000	100	1600	0.30	0.8
	1.5	16	10000	100	1600	0.30	0.8
S Cobalt chromium alloy	0.5	8	25000	80	2000	0.05	0.1
	0.5	10	19000	60	1500	0.05	0.1
	0.5	12	19000	60	1500	0.03	0.1
	0.75	10	17000	80	1700	0.08	0.1
	0.75	12	13000	60	1200	0.08	0.1
	1	10	13000	80	1500	0.2	0.5
	1	12	13000	80	1500	0.2	0.5
	1.5	12	8500	80	1300	0.3	0.8
	1.5	14	8500	80	1300	0.3	0.8
	1.5	16	8500	80	1300	0.3	0.8
Pure titanium	0.5	8	27000	80	1600	0.08	0.1
	0.5	10	19000	60	1200	0.08	0.1
	0.5	12	19000	60	1200	0.04	0.1
	0.75	10	25000	120	2000	0.13	0.2
	0.75	12	21000	100	1600	0.13	0.2
	1	10	32000	200	2500	0.32	0.8
	1	12	29000	180	1700	0.32	0.8
	1.5	12	21000	200	1600	0.48	1.2
	1.5	14	21000	200	1600	0.48	1.2
	1.5	16	21000	200	1600	0.48	1.2

1/1

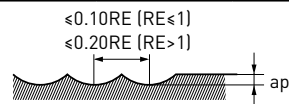

1. SMART MIRACLE coating has very low electrical conductivity; therefore, an electrical contact type of tool setter may not work. When measuring the tool length, please use a mechanical contact type or a laser tool setter.
2. When machining titanium alloys, the use of water-soluble cutting fluid is effective.
3. If the depth of cut is smaller, the revolution and the feed rate can be increased.

VQN4MB



BALL NOSE, MEDIUM CUT LENGTH, 4 FLUTE

S

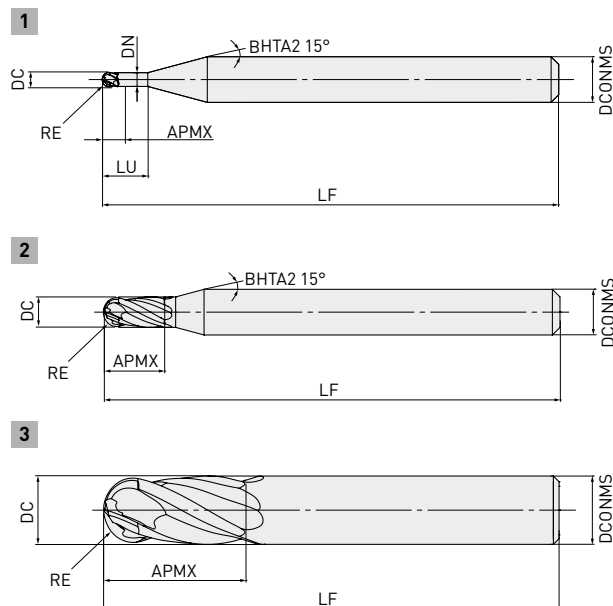
RE \leq 6 ± 0.010 DCONMS=6 8 \leq DCONMS \leq 10 DCONMS=12

0

0

0

-0.005

-0.006

-0.008

- The (Al, Ti, Si) N-based coating provides excellent wear and chipping resistance when machining heat resistant super alloys.
- The 4-flute end cutting edge provides excellent chip evacuation and is ideal for rough machining.

Order number	Stock	DC	RE	APMX	LF	LU	DN	DCONMS	ZEFP	Type
VQN4MBR0100	●	2	1.0	2	60	6	1.9	6	4	1
VQN4MBR0150	●	3	1.5	3	60	8	2.9	6	4	1
VQN4MBR0200	●	4	2.0	8	60	—	—	6	4	2
VQN4MBR0250	●	5	2.5	12	60	—	—	6	4	2
VQN4MBR0300	●	6	3.0	12	60	—	—	6	4	3
VQN4MBR0400	●	8	4.0	14	70	—	—	8	4	3
VQN4MBR0500	●	10	5.0	18	80	—	—	10	4	3
VQN4MBR0600	●	12	6.0	22	80	—	—	12	4	3

1/1

106

VQN4MB

RECOMMENDED CUTTING CONDITIONS

Material	RE	$\alpha \leq 15^\circ$		$\alpha > 15^\circ$		ap	ae
		n	f	n	f		
S Nickel-based heat resistant super alloy Inconel®718, Inconel®713C, WASPALLOY® etc.	1.0	6300	380	6300	510	0.2	0.50
	1.5	4200	340	4200	420	0.3	0.75
	2.0	3100	320	3100	380	0.4	1.00
	2.5	2500	250	2500	310	0.5	1.25
	3.0	2100	210	2100	250	0.6	1.50
	4.0	1500	160	1500	190	0.8	2.00
	5.0	1200	150	1200	200	1.0	2.50
	6.0	1000	150	1000	170	1.2	3.00

1/1

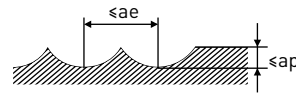

1. For machining heat resistant super alloys, the use of water-soluble coolant is effective.
2. If the depth of cut is shallow, the revolution and feed rate can be increased.
3. Vibration may occur if the rigidity of machine or workpiece is low. In this case, please reduce the revolution and feed rate proportionately.
4. α is the inclination angle of the machined surface.

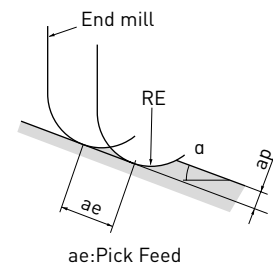

VQN4MBF



BALL NOSE, MEDIUM CUT LENGTH, 4 FLUTE

S

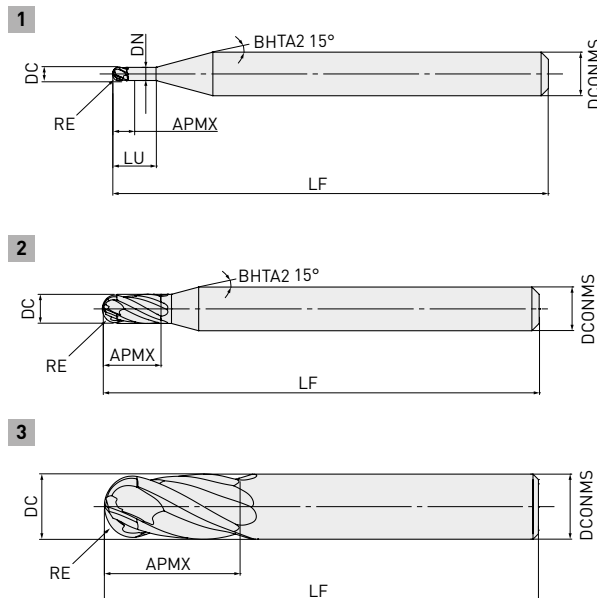

	RE ≤ 6
	±0.010
	DCONMS=6 8 < DCONMS < 10 DCONMS=12
	0 0 0
	-0.005 -0.006 -0.008

- The (Al, Ti, Si) N-based coating provides excellent wear and chipping resistance when machining heat resistant super alloys.
- The 4-flute end cutting edge is also ideal for 5-axis machining.

Order number	Stock	DC	RE	APMX	LF	LU	DN	DCONMS	ZEFP	Type
VQN4MBFR0100	●	2	1.0	2	60	6	1.9	6	4	1
VQN4MBFR0150	●	3	1.5	3	60	8	2.9	6	4	1
VQN4MBFR0200	●	4	2.0	8	60	—	—	6	4	2
VQN4MBFR0250	●	5	2.5	12	60	—	—	6	4	2
VQN4MBFR0300	●	6	3.0	12	60	—	—	6	4	3
VQN4MBFR0400	●	8	4.0	14	70	—	—	8	4	3
VQN4MBFR0500	●	10	5.0	18	80	—	—	10	4	3
VQN4MBFR0600	●	12	6.0	22	80	—	—	12	4	3

1/1

VQN4MBF

RECOMMENDED CUTTING CONDITIONS

Material	RE	$\alpha \leq 15^\circ$			$\alpha > 15^\circ$			ap
		n	f	ae	n	f	ae	
S Nickel-based heat resistant super alloy Inconel®718, Inconel®713C, WASPALLOY® etc.	1.0	6300	180	0.40	6300	310	0.50	0.2
	1.5	4200	170	0.60	4200	340	0.75	0.3
	2.0	3100	190	0.80	3100	320	1.00	0.4
	2.5	2500	150	1.00	2500	250	1.25	0.5
	3.0	2100	170	1.20	2100	250	1.50	0.6
	4.0	1500	130	1.60	1500	190	2.00	0.8
	5.0	1200	100	2.00	1200	200	2.50	1.0
	6.0	1000	130	2.40	1000	170	3.00	1.2

1/1

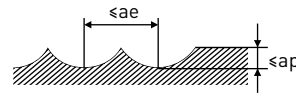

1. For machining heat resistant super alloys, the use of water-soluble coolant is effective.
2. If the depth of cut is shallow, the revolution and feed rate can be increased.
3. Vibration may occur if the rigidity of machine or workpiece is low. In this case, please reduce the revolution and feed rate proportionately.
4. α is the inclination angle of the machined surface.

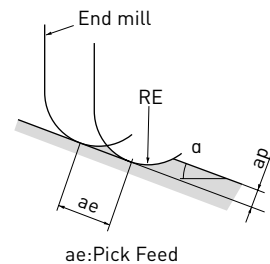

VQ4SVB



45°



BALL NOSE, SHORT CUT LENGTH, 4 FLUTE, VARIABLE CURVE

P M N S

 $1 < R < 6$

±0.01



DC < 12

0
-0.02

D4 = 6	8 < D4 < 10	D4 = 20
0	0	0
-0.008	-0.009	-0.011

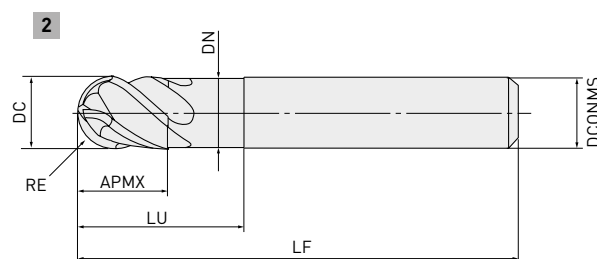
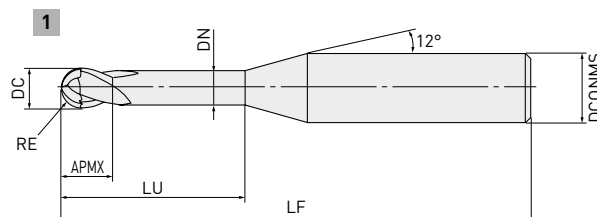

- 4 flute vibration control ball nose end mill with VQ coating.
- Ideal for finishing.

Order number	Stock	DC	RE	APMX	LF	LU	DN	DCONMS	ZFP	Type
VQ4SVBR0100	●	2	1	3	50	5	1.9	6	4	1
VQ4SVBR0150	●	3	1.5	4.5	50	7.5	2.9	6	4	1
VQ4SVBR0200	●	4	2	6	50	10	3.9	6	4	1
VQ4SVBR0250	●	5	2.5	7.5	50	12.5	4.9	6	4	1
VQ4SVBR0300	●	6	3	9	50	15	5.85	6	4	2
VQ4SVBR0400	●	8	4	12	60	20	7.85	8	4	2
VQ4SVBR0500	●	10	5	15	70	25	9.7	10	4	2
VQ4SVBR0600	●	12	6	18	75	30	11.7	12	4	2

1/1

110

VQ4SVB

RECOMMENDED CUTTING CONDITIONS

SHOULDER MILLING (SLOTTING)

Material	RE	$\alpha \leq 15^\circ$		$\alpha > 15^\circ$		ap	pf
		n	Vf	n	Vf		
P Carbon steel, Alloy steel, Mild steel, Pre-hardened steel	R 1	40000	8000	40000	8000	0.1	0.5
	R 1.5	32000	7700	32000	7700	0.2	0.7
	R 2	24000	5800	24000	5800	0.3	1
	R 2.5	19000	5300	19000	5300	0.4	1.2
	R 3	16000	4800	16000	4800	0.5	1.5
	R 4	12000	4300	12000	4300	0.8	2
	R 5	9600	4100	9600	4100	1	2.5
M Austenitic stainless steel, Titanium alloy, Hardened stainless steel, Cobalt chromium alloy, Ferritic and martensitic stainless steel	R 1	36000	6500	24000	2900	0.1	0.5
	R 1.5	24000	4800	16000	1900	0.2	0.7
	R 2	18000	4000	12000	1700	0.3	1
	R 2.5	14400	3500	9600	1500	0.4	1.2
	R 3	12000	3200	8000	1400	0.5	1.5
	R 4	9000	3200	6000	1400	0.8	2
	R 5	7200	3000	4800	1300	1	2.5
N Copper, Copper alloy	R 1	40000	8000	38000	4500	0.1	0.5
	R 1.5	38000	9100	25000	3800	0.2	0.7
	R 2	29000	7000	19000	3300	0.3	1
	R 2.5	23000	6400	15000	3100	0.4	1.2
	R 3	19000	5700	13000	2600	0.5	1.5
	R 4	14000	5000	9600	2300	0.8	2
	R 5	12000	5100	7700	2200	1	2.5
S Heat resistant alloy	R 1	9600	960	6400	510	0.08	0.2
	R 1.5	6400	640	4200	340	0.1	0.3
	R 2	4800	580	3200	260	0.1	0.4
	R 2.5	3800	530	2500	250	0.2	0.5
	R 3	3200	500	2100	210	0.2	0.6
	R 4	2400	430	1600	190	0.4	0.8
	R 5	2000	420	1300	180	0.5	1
R 6	1700	350	1100	150	0.6	1.2	

1/1

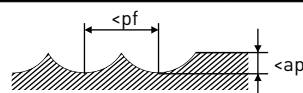

1. SMART MIRACLE coating has very low electrical conductivity; therefore, an electrical contact type of tool setter may not work. When measuring the tool length, please use a mechanical contact type or a laser tool setter.
2. Effective machining of stainless steel, titanium alloys and heat-resistant alloys etc. can be achieved with the use of emulsion coolant.
3. Chattering can still occur if the machine rigidity and clamping method are insufficient. In these cases the feed and speed should be reduced proportionately.
4. When the depth of cut is smaller than shown the revolution and feed rate can be increased.

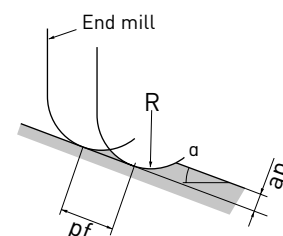

VQ4WB



30°



DC

MULTI-FUNCTIONAL LOLLIPOP, SHORT CUT LENGTH, 4 FLUTE

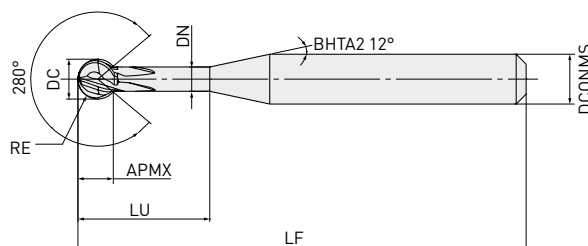
 $0.5 \leq RE \leq 3$
 ± 0.01

 $4 \leq DCONMS \leq 6$

0

-0.008

- Multi-functional ball end mill with a lollipop geometry for 5-axis machining.
- Optimal for back deburring, undercutting and inner curved surface machining.

Order number	Stock	DC	RE	APMX	LF	LU	DN	DCONMS	ZEFP
VQ4WBR0050N06E280	●	1	0.5	0.88	50	6	0.62	4	4
VQ4WBR0065N08E280	●	1.3	0.65	1.15	50	8	0.81	4	4
VQ4WBR0090N06E280	●	1.8	0.9	1.59	50	6	1.13	4	4
VQ4WBR0100N06E280	●	2	1	1.77	60	6	1.26	6	4
VQ4WBR0140N16E280	●	2.8	1.4	2.47	60	16	1.77	6	4
VQ4WBR0150N08E280	●	3	1.5	2.65	60	8	1.9	6	4
VQ4WBR0190N12E280	●	3.8	1.9	3.36	60	12	2.37	6	4
VQ4WBR0200N12E280	●	4	2	3.53	60	12	2.54	6	4
VQ4WBR0240N16E280	●	4.8	2.4	4.24	70	16	3.06	6	4
VQ4WBR0250N12E280	●	5	2.5	4.42	80	12	3.19	6	4
VQ4WBR0300N12E280	●	6	3	5.3	80	12	3.83	6	4

1/1

1. SMART MIRACLE coating has very low electrical conductivity; therefore, an electrical contact type of tool setter may not work. When measuring the tool length, please use a mechanical contact type or a laser tool setter.

112

Special Orders

For non standard products not shown above, please contact our sales department.

VQ4WB

RECOMMENDED CUTTING CONDITIONS

CHAMFERING (DEBURRING)

Material	DC	RE	n	Vf	Max. CF
P Mild steel, Carbon steel, Copper alloy, Pre-hardened steel (-45HRC)	1.0	0.5	19000	300	0.10
	1.3	0.65	15000	420	0.13
	1.8	0.9	11000	570	0.18
	2.0	1.0	9500	610	0.20
	2.8	1.4	6800	760	0.28
N	3.0	1.5	6400	770	0.30
	3.8	1.9	5000	840	0.38
	4.0	2.0	4800	880	0.40
	4.8	2.4	4000	960	0.48
	5.0	2.5	3800	970	0.50
M	6.0	3.0	3200	1000	0.60
	1.0	0.5	14000	220	0.10
	1.3	0.65	11000	310	0.13
	1.8	0.9	8000	420	0.18
	2.0	1.0	7200	460	0.20
S Austenitic, Ferritic and martensitic stainless steel, Precipitation hardening stainless steel, Cobalt chrome alloy, Titanium alloy	2.8	1.4	5100	570	0.28
	3.0	1.5	4800	580	0.30
	3.8	1.9	3800	640	0.38
	4.0	2.0	3600	660	0.40
	4.8	2.4	3000	720	0.48
S	5.0	2.5	2900	740	0.50
	6.0	3.0	2400	770	0.60

1/1

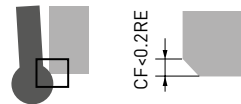

INTERNAL PROFILE/UNDERCUT

Material	DC	RE	n	Vf	ae
P Mild steel, Carbon steel, Copper alloy, Pre-hardened steel (-45HRC)	2.0	1.0	9500	460	0.03
	3.0	1.5	6400	560	0.10
	4.0	2.0	4800	650	0.14
N	5.0	2.5	3800	730	0.18
	6.0	3.0	3200	770	0.22
M	2.0	1.0	7200	290	0.03
	3.0	1.5	4800	350	0.10
S Austenitic, Ferritic and martensitic stainless steel, Precipitation hardening stainless steel, Cobalt chrome alloy, Titanium alloy	4.0	2.0	3600	390	0.14
	5.0	2.5	2900	440	0.18
	6.0	3.0	2400	460	0.22

1/1



VQ4WB

RADIUSED GEOMETRY MACHINING

Material	DC	RE	n	Vf	ae	Max. ae
P Mild steel, Carbon steel,	2.0	1.0	9500	300	0.03	0.06
	3.0	1.5	6400	380	0.10	0.20
N Copper alloy, Pre-hardened steel [-45HRC]	4.0	2.0	4800	440	0.14	0.28
	5.0	2.5	3800	490	0.18	0.54
	6.0	3.0	3200	510	0.22	0.88
M Austenitic, Ferritic and martensitic stainless steel,	2.0	1.0	7200	140	0.03	0.06
	3.0	1.5	4800	190	0.10	0.20
S Precipitation hardening stainless steel, Cobalt chrome alloy, Titanium alloy	4.0	2.0	3600	230	0.14	0.28
	5.0	2.5	2900	260	0.18	0.54
	6.0	3.0	2400	270	0.22	0.88

1/1

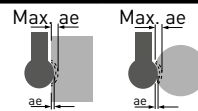

1. SMART MIRACLE coating has very low electrical conductivity; therefore, an electrical contact type of tool setter may not work. When measuring the tool length, please use a mechanical contact type or a laser tool setter.
2. If the depth of cut is smaller than this table, feed rate can be increased.
3. If the rigidity of the machine or the workpiece material installation is very low, or chattering is generated, please reduce the revolution and the feed rate proportionately.
4. For sizes RE 0.5, 0.65, 0.9, 1.4, 1.9 and RE 2.4 which have long neck lengths, internal profile milling and round shape slotting are not recommended.
5. The maximum allowed depth of cut (Max ae) avoids interference between the workpiece and tool shank. It is recommended to machine up to the Max ae in 2-4 passes.

VQT6UR



CONICAL TAPER BARREL, MEDIUM CUT LENGTH, 6 FLUTE

P M N S

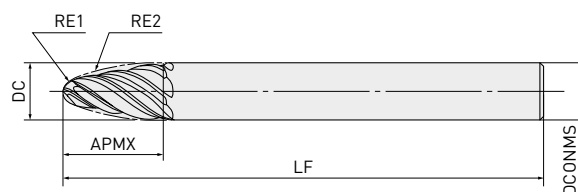

RE1 ≤4	RE2 ≤100
--------	----------

±0.01	±0.01
-------	-------



DCONMS ≤10	DCONMS = 12
------------	-------------

0	0
- 0.009	- 0.009

Order number	Stock	DC	RE1	RE2	APMX	LF	DCONMS	ZEFP
VQT6URR020R075S08	●	8	2	75	21	90	8	
VQT6URR020R085S10	●	10	2	85	26	100	10	
VQT6URR030R075S10	●	10	3	75	22	100	10	6
VQT6URR040R100S12	●	12	4	100	25	110	12	

1/1

1. SMART MIRACLE coating has very low electrical conductivity; therefore, an electrical contact type of tool setter may not work. When measuring the tool length, please use a mechanical contact type or a laser tool setter.

115

VQT6UR

RECOMMENDED CUTTING CONDITIONS

EFFECTIVE ANGLE

Please refer to the table below for the use of the nose radius RE1 and tangential form radius RE2.

RE2

SIDE MILLING WITH THE USE OF THE TANGENTIAL FORM RADIUS

Order number	Nose radius		Tangential form radius		Effective angle
	RE1	Effective angle	RE2	Effective angle	
VQT6URR020R075S08	2	76.6°	75	13.4°	
VQT6URR020R085S10	2	74.5°	85	15.5°	
VQT6URR030R075S10	3	76.4°	75	13.6°	
VQT6URR040R100S12	4	78.3°	100	11.7°	

Material	DC	RE2	n	Vf	ap	ae
P Mild steel ($\leq 180\text{HB}$) Carbon steel, Cast irons (180 – 280HB)	8	75	8000	2400	0.78	0.005 – 0.3
	10	85	6400	1900	0.83	
	10	75	6400	1900	0.78	
	12	100	5300	1600	0.89	
M S Austenitic stainless steel ($\leq 200\text{HB}$) Titanium alloy	8	75	3200	770	0.78	0.005 – 0.3
	10	85	2500	600	0.83	
	10	75	2500	600	0.78	
N Aluminum alloy (Si < 5 %)	12	100	2100	500	0.89	0.005 – 0.3
	8	75	16000	4800	0.78	
	10	85	13000	3900	0.83	
	10	75	13000	3900	0.78	
	12	100	11000	3300	0.89	

1/1

1. SMART MIRACLE coating has very low electrical conductivity; therefore, an electrical contact type of tool setter may not work. When measuring the tool length, please use a mechanical contact type or a laser tool setter.
2. It is recommended to use this tool only for finish cutting.
3. The tool contact differs between the nose radius and tangential form radius depending on the machining geometries and tilt angles. Select suitable cutting conditions according to the tool contact area.

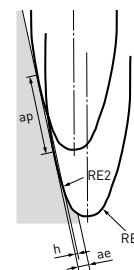

DEPTH OF CUT CALCULATION TABLE BASED ON TANGENTIAL FORM RADIUS AND CUSP HEIGHT (H)

Material	RE2	Cusp height h	0.0001	0.0003	0.0005	0.0008	0.001	0.003	0.005	0.008
VQT6URR020R075S08	75	ap	0.245	0.424	0.548	0.693	0.775	1.342	1.732	2.191
VQT6URR020R085S10	75		0.245	0.424	0.548	0.693	0.775	1.342	1.732	2.191
VQT6URR030R075S10	85		0.261	0.452	0.583	0.738	0.825	1.428	1.844	2.332
VQT6URR040R100S12	100		0.283	0.49	0.632	0.8	0.894	1.549	2	2.53

VQT6UR

RE1

SIDE MILLING WITH THE USE OF THE NOSE RADIUS

Material	DC	RE2	n	Vf	ap	ae
P Mild steel ($\leq 180\text{HB}$) Carbon steel, Cast irons (180 – 280HB)	8	2	16000	2400	0.4	1
	10	2	16000	2400	0.4	1
	10	3	11000	1700	0.6	1.5
	12	4	8000	1200	0.8	2
M Austenitic stainless steel ($\leq 200\text{HB}$)	8	2	6400	580	0.4	1
	10	2	6400	580	0.4	1
S Titanium alloy	10	3	4200	380	0.6	1.5
	12	4	3200	290	0.8	2
N Aluminum alloy (Si < 5 %)	8	2	32000	4800	0.4	1
	10	2	32000	4800	0.4	1
	10	3	21000	3200	0.6	1.5
	12	4	16000	2400	0.8	2

1/1

1. SMART MIRACLE coating has very low electrical conductivity; therefore, an electrical contact type of tool setter may not work. When measuring the tool length, please use a mechanical contact type or a laser tool setter.
2. It is recommended to use this tool only for finish cutting.
3. The tool contact differs between the nose radius and tangential form radius depending on the machining geometries and tilt angles. Select suitable cutting conditions according to the tool contact area.

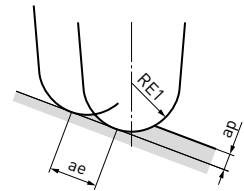

EUROPEAN SALES COMPANIES

GERMANY

MMC HARTMETALL GMBH
Comeniusstr. 2 . 40670 Meerbusch
Phone +49 2159 91890 . Fax +49 2159 918966
Email admin@mmchg.de

UK Office

MMC HARDMETAL UK LTD
1 Centurion Court, Centurion Way
Tamworth, B77 5PN
Phone +44 1827 312312
Email enquiries@mitsubishicarbide.co.uk

UK Deliveries / Returns

Unit 4 B5K Business Park, Quartz Close
Tamworth, B77 4GR

SPAIN

MITSUBISHI MATERIALS ESPAÑA, S.A.
Calle Emperador 2 . 46136 Museros /Valencia
Phone +34 96 1441711
Email comercial@mmevalencia.es

FRANCE

MMC METAL FRANCE S.A.R.L.
6, Rue Jacques Monod . 91400 Orsay
Phone +33 1 69 35 53 53 . Fax +33 1 69 35 53 50
Email mmfsales@mmc-metal-france.fr

POLAND

MMC HARDMETAL POLAND SP. Z O.O
Al. Armii Krajowej 61 . 50-541 Wrocław
Phone +48 71335 1620 . Fax +48 71335 1621
Email sales@mitsubishicarbide.com.pl

ITALY

MMC ITALIA S.R.L.
Viale Certosa 144 . 20156 Milano
Phone +39 0293 77031 . Fax +39 0293 589093
Email info@mmc-italia.it

TURKEY

MMC HARTMETALL GMBH ALMANYA - İZMİR MERKEZ ŞUBESİ
Adalet Mahallesi Anadolu Caddesi No: 41-1 . 15001 35530 Bayraklı /İzmir
Phone +90 232 5015000 . Fax +90 232 5015007
Email info@mmchg.com.tr

www.mmc-carbide.com

DISTRIBUTED BY:

□

□

L

┘

B197E 

Published by: MMC Hartmetall GmbH – A Sales Company of  MITSUBISHI MATERIALS | 2025.04